

B&G

H5000

Installation Manual

ENGLISH



www.bandg.com

Preface

As Navico is continuously improving this product, we retain the right to make changes to the product at any time which may not be reflected in this version of the manual. Please contact your nearest distributor if you require any further assistance.

It is the owner's sole responsibility to install and use the instrument and transducers in a manner that will not cause accidents, personal injury or property damage. The user of this product is solely responsible for observing safe boating practices.

NAVICO HOLDING AS AND ITS SUBSIDIARIES, BRANCHES AND AFFILIATES DISCLAIM ALL LIABILITY FOR ANY USE OF THIS PRODUCT IN A WAY THAT MAY CAUSE ACCIDENTS, DAMAGE OR THAT MAY VIOLATE THE LAW.

Governing Language: This statement, any instruction manuals, user guides and other information relating to the product (Documentation) may be translated to, or has been translated from, another language (Translation). In the event of any conflict between any Translation of the Documentation, the English language version of the Documentation will be the official version of the Documentation.

This manual represents the product as at the time of printing. Navico Holding AS and its subsidiaries, branches and affiliates reserve the right to make changes to specifications without notice.

Copyright

Copyright © 2014 Navico Holding AS.

Warranty

The warranty card is supplied as a separate document.

In case of any queries, refer to the brand web site of your display or system:

www.bandg.com

→ **Note:** Used to draw the reader's attention to a comment or some important information.

 **Warning :** Used when it is necessary to warn personnel that they should proceed carefully to prevent risk of injury and/or damage to equipment/personnel.

Declarations and conformance

This equipment is intended for use in international waters as coastal sea area administered by countries of the E.U. and E.E.A.

The H5000 system complies with the following regulations:

- CE under EMC directive 2004/108/EC
 - Level 2 devices of the Radio communications (Electromagnetic Compatibility) standard 2008
 - The relevant Declaration of conformity is available in the H5000 section on the following website: www.bandg.com
- H5000 displays meet the technical standards in accordance with Part 15.103 of the FCC rules.



About this manual

This manual is a reference guide for installing and commissioning the H5000 Instrument and autopilot system. The manual assumes that the installer has at very least, basic knowledge of DC electrical systems, and of working with power tools with materials such as fiberglass and wood.

An understanding of basic navigation, nautical terminology and practices may be helpful in correct configuration of the product.

⚠ Warning : It is your sole responsibility to install and use the instrument and transducer(s) in a manner that will not cause accidents, personal injury or property damage. Always observe safe boating practices.

- **Note:** The choice, location, and installation of transducers and other components of the system are critical to the performance of the system as intended. If in doubt, consult your dealer.
- **Note:** Global Positioning System: The Global Positioning System (GPS) is operated by the US Government which is solely responsible for its operation, accuracy and maintenance. The GPS is subject to changes which could affect the accuracy and performance of all GPS equipment anywhere in the world, including this system.

Liability and safety warning

Navico accept no responsibility for the use and/or operation of this equipment. It is the user's responsibility to ensure that under all circumstances the equipment is used for the purposes for which it has been designed.

Warning: Calibration

The safe operation of this equipment is dependent on accurate and correct calibration. Incorrect calibration of this equipment may lead to false and inaccurate navigational readings placing the yacht into danger.

Warning: Operational Hazard

The H5000 system is an electronic navigation aid and is designed to assist in the navigation of your yacht. It is not designed to totally replace conventional navigation procedures and precautions. All necessary precautions should be taken to ensure that the yacht is not placed into danger.

The Pilot is an aid to steering the vessel. It is the user's responsibility to ensure safe control and movement of the vessel at all times.

Caution: Electrical Supply

This equipment is designed for use with a power supply source of 12V DC. The application of any other power supply may result in permanent damage to the equipment.

Caution: Cleaning

The use of alcohol or solvent-based cleaners will damage this equipment and any warranty in force will be invalidated.

Caution: Processor Installation

All B&G Processors should be installed below decks in a dry location protected from water and moisture.

Power Off Disclaimer

When in standby mode the H5000 system continues to consume power. To conserve the vessel's battery life switch off power at the main breaker.

Contents

7	Introduction
7	About B&G
7	About this manual
8	System introduction
9	H5000 system example
10	H5000 performance system example
11	H5000 typical autopilot system
12	Planning
12	Mounting locations
14	System architecture
14	NMEA 2000® device connection
15	Wiring guidelines
16	Network layout
17	Bridged network
18	Network power supply
19	H5000 Central Processor Unit - CPU
20	Status LEDs
21	CPU Installation
25	H5000 Central Processor wiring
26	Power supply
26	Masthead Unit
26	Analog input 3 & 4
27	Analog input 1 & 2
27	Pulse (Paddlewheel - Speed)
27	Man Overboard Button input
28	Digital output (Alarm)
28	NMEA 0183 - Channel 2
29	NMEA 0183 - Channel 1
29	Network (NMEA 2000 compatible)
29	USB update port
30	Reset button
30	Ethernet port
31	Webserver
31	Connections
33	Expansion Modules
34	H5000 Expansion Module wiring
35	H5000 Expansion Module wiring example
36	Module Jumpers

37	External sensor wiring
	Analog Expansion
37	Masthead unit
37	5 V Analog input / 0 V to +5 V signal
38	Paddle wheel
39	Paddle wheel & Sea temperature
40	External sensor wiring
	Serial Expansion
40	NMEA 0183 - GPS Antenna
40	Halcyon Gyro Stabilized Compass - HGSC
41	Sensor Modules
42	Autopilot
42	H5000 Pilot Computer
42	General
42	Wiring
43	Power
43	Drive
44	Engage (Clutch)
44	Alarm
45	NMEA 0183
45	Rudder
45	Remote
46	Simnet (Network)
46	Turning on for the first time
47	H5000 Pilot Controller
49	Commissioning
49	Dockside
57	Maintenance
57	General maintenance
58	Software upgrade
58	H5000 CPU
59	H5000 Pilot Computer / Pilot Controller
59	Graphic Display
60	Race display
60	Analog / Serial expansion module
60	Navico NMEA 2000 devices
61	Technical drawings & specifications
61	H5000 Central Processor Unit - CPU
62	Graphic Display
63	Race display
64	H5000 Pilot Computer
65	H5000 Pilot Controller

1

Introduction

About B&G

B&G has welcomed the constant challenge to develop new electronic solutions for every sailor's need. Harnessing technical developments and providing proven solutions has continued to be the focus that keeps B&G on the leading edge of advanced marine electronics.

Proven in the world's most testing environments, B&G offers the most accurate and reliable systems used by blue water cruisers, single-handed racers and record breakers alike, firmly establishing ourselves as one of the leading innovators of the most highly advanced marine electronics. B&G is renowned for tried and trusted solutions and is ever evolving to offer the best technology to the customer.

About this manual

Instructions in this handbook describe the installation and routine maintenance of the H5000 system.

2

System introduction

The innovative B&G H5000 instrument system is powered by a smart Central Processing Unit (CPU) with the ability to run three levels of software, Hydra, Hercules and Performance. H5000 is designed for all sailing types from cruising to racing and provides the sophistication you need without over-complication.

Running a system with an integral CPU has a wealth of advantages including web-browser based setup via the new H5000 interface, for easy set-up, calibration, commissioning, backup/restore and advanced diagnostics. It also expands the system's communications capabilities, with dual NMEA 0183 ports with selectable message configuration, Ethernet link to the webserver and the ability to interface with other software apps. Add a wireless router and you benefit from tablet/smartphone integration. A CPU provides enhanced sensor support and specific sailing features like wind correction for heel/trim angle and true wind correction – improving the data displayed to the user and guiding the autopilot. It also simplifies seemingly complex calibrations through AutoCal calibration routines.

The H5000 CPU delivers enhanced HV display control, letting you alternate the displays between two variables, for more efficient display use, and provides support for both expansion modules and many of B&G's existing sensors. In addition, the CPU provides advanced MOB function with dedicated MOB button input and dead reckoning of relative MOB position, allowing for tide, based on the initial MOB position or as updated via AIS SART with compatible equipment.

This manual describes the standard system and then describes how the system can be expanded.

The system is connected together by the NMEA 2000® communication network using Micro-C connectors, which handles all of the data that travels between devices including the Central Processor Unit, Pilot Computer, Modules, Analog Displays, Graphic & Race Displays, Pilot Controller and HV Displays.

H5000 system example

An example of a typical H5000 system. At the centre of the system is the Central Processor Unit (CPU). All sensor information is fed back to the CPU and can be easily controlled and configured via the Graphic Display or webserver.

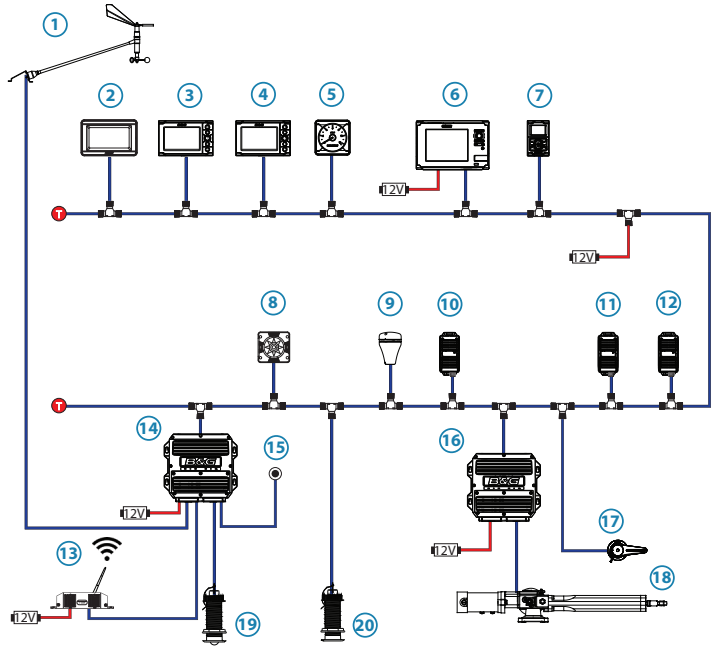

No.	Description	No.	Description
1	213 Masthead unit	11	3D Motion sensor
2	HV Display	12	Alarm module
3	Graphic Display	13	Wireless Access Point or Router
4	Race display	14	H5000 CPU
5	Analog display	15	Man Overboard Button
6	Zeus Touch	16	H5000 Pilot Computer
7	H5000 Pilot Controller	17	Rudder Feedback Unit
8	Heading sensor	18	Hydraulic Ram
9	GPS antenna	19	Speed sensor
10	High-Resolution Barometer	20	Depth sensor
Ⓡ	Micro-C Terminator	12V	12 Volt DC power

H5000 performance system example

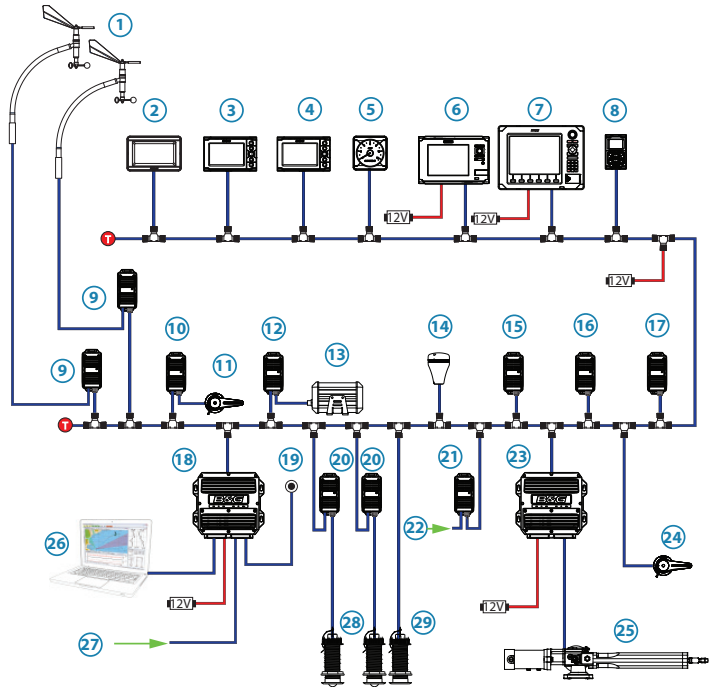

No.	Description	No.	Description
1	Fwd & Aft vertical MHU	16	Motion sensor
2	HV Display	17	Alarm module
3	Graphic Display	18	H5000 CPU
4	Race Display	19	Man Overboard Button
5	Analogue display	20	Analog module
6	Zeus Touch	21	Analog module
7	Zeus	22	Analog sensor
8	H5000 Pilot Controller	23	H5000 Pilot Computer
9	Analog module	24	Rudder Feedback Unit
10	Analog module	25	Hydraulic ram
11	Mast rotation sensor	26	Deckman via serial port
12	Serial Expansion Module	27	NMEA 0183 Tx / Rx
13	Halcyon Gyro Stabilized Compass	28	Port & Starboard speed sensor
14	GPS	29	Depth sensor
15	Barometric & Air temp sensor		
T	Micro-C Terminator	12V	12 Volt DC power

H5000 typical autopilot system

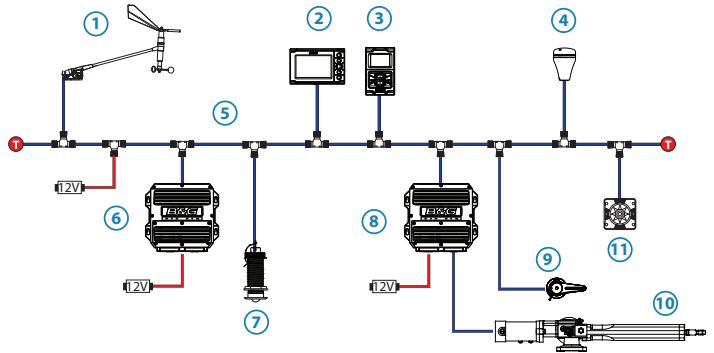

No.	Description	No.	Description
1	Masthead unit	7	DST800 combined Speed / Depth / Temperature sensor
2	Graphic Display	8	H5000 Pilot Computer
3	H5000 Pilot Controller	9	Rudder Feedback Unit
4	GPS antenna	10	Hydraulic Ram
5	Micro-C CAN bus backbone	11	Compass
6	H5000 CPU		
T	Micro-C Terminator	12V	12 Volt DC power

3

Planning

Mounting locations

H5000 CPU

The H5000 CPU should be installed in a dry place with easy accessibility. The enclosure is water resistant to IP65 but will not survive prolonged immersion. The engine box is NOT a good place to install your instrument system processors; it is hot and electrically noisy. The H5000 CPU does not contain orientation sensitive components so it is NOT necessary to mount the unit vertically, however it is recommended to orientate the unit with all cable exits downwards.

Displays

Choose the mounting locations carefully before you drill or cut. Displays should be mounted so that the operator can easily use the controls and clearly see the display screen. Ensure that the suncover can be easily fitted and removed. Be sure to leave a direct path for all of the cables. B&G displays are high-contrast and anti-reflective, and are viewable in direct sunlight, but for best results install the display out of direct sunlight. The chosen location should have minimal glare from windows or bright objects.

The enclosure that the display is mounted in should be dry and well ventilated. The ventilation of the space behind the unit should be enough to prevent excessive heat build up as a combined result of radiated heat off the heat sink, and sunlight heating of the enclosure. In very small enclosures, also subject to heating from the sun, it may be required to fit forced cooling.

→ **Note:** Graphic Displays should be located or mounted in such a way as to retain access to the service port on the rear of the unit.

H5000 Pilot Controller

The H5000 Pilot Controllers should be mounted with special regard to the units' environmental protection, temperature range and cable length.

→ **Note:** If installed outdoors, select a position and a mounting option that prevents water from remaining on the display. It is recommended to cover the units with their suncover when not in use.

General

Ensure that any holes cut are in a safe position and will not weaken the boat's structure. If in doubt, consult a qualified boat builder.

Before cutting a hole in a panel, make sure that there are no hidden electrical wires or other parts behind the panel.

Do not mount any part where it can be used as a hand hold, where it might be submerged, or where it will interfere with the operation, launching or retrieving of the boat.

Leave sufficient clearance space to connect all relevant cables.

For overall width and height requirements, please see the dimensions section and mounting template of each device.

4

System architecture

NMEA 2000® device connection

All devices connect to the network via a Micro-C connector.

Essential network information

- The network consists of a linear “backbone” from which “drop cables” connect to H5000 and NMEA 2000 devices
 - H5000 products use Micro-C style connectors, this allows compatibility with NMEA 2000 networks.
- **Note:** Some B&G products use Simnet proprietary connectors, but are compatible via adaptor cables.
- A single drop cable has a maximum length of 6 m (20 ft). The total length of all drop cables combined should not exceed 78 m (256 ft)
 - The network has a maximum cable length of 100 m (328 ft), between any two terminators
 - The network needs to have a Micro-C Terminator at each end of the backbone. A Micro-C Terminator can be one of the following:
 - A Micro-C Terminator blank plug
 - A 508 model wind transducer (where the mast cable is one end of the backbone)

Planning and installing a network backbone

The network backbone needs to run between the locations of all products you want to install, typically in a bow to stern layout, and be no further than 6 m from a device to be connected.

Choose from the following components to make up your network backbone:

- Micro-C interconnecting cables
 - Micro-C power cables - with or without termination
 - T-connectors. Use at locations where you want to connect a device by drop cable
- **Note:** If using a 508 wind sensor connected directly to the network, the mast cable should be connected as the final length of cable at one end of the backbone, as the sensor is fitted with a termination resistor.
- **Note:** Most NMEA 2000 devices can be connected directly to the network backbone. Simnet devices can be connected to the Micro-C CAN bus backbone by using adapter cables.

Wiring guidelines

The network cabling should be such that the network cable run is predominantly in a linear layout with a start point and end point (which are terminated). “Star” shaped layouts are inefficient, may cause incorrect operation and should be avoided.

→ **Note:** H5000 uses Micro-C network cabling compatible with NMEA 2000 devices.

Don't do this...	Do this...
Don't make sharp bends in the cables	Do make drip and service loops
Don't run cables in a way that allows water to flow down into the connectors	Do tie-wrap all cables to keep them secure
Don't route the data cables in areas adjacent to radar, transmitter, or large current carrying cables	If cables are shortened, lengthened, or re-terminated, do insulate and protect all wiring connections
	Do leave room at the back to install and remove cables

 **Warning** : Before starting the installation, be sure to turn electrical power off. If power is left on or turned on during the installation, fire, electrical shock, or other serious injury may occur. Be sure that the voltage of the power supply is compatible with the system.

Network layout

Guideline maximum drop cable length

For best performance it is recommended that drop cables (x) are kept short. However in some cases it may be necessary to utilise longer drops, in this case they should not exceed 6 meters.

- **Note:** The maximum cable length of the Micro-C network backbone is 100 meters. For larger systems a network bridge should be considered or use Mini-C cable for the network backbone which would allow a maximum of 200 meters.

Backbone length is calculated by adding cable lengths a, b and c as shown below.

- **Note:** Cable lengths a & c should not exceed 6 meters.

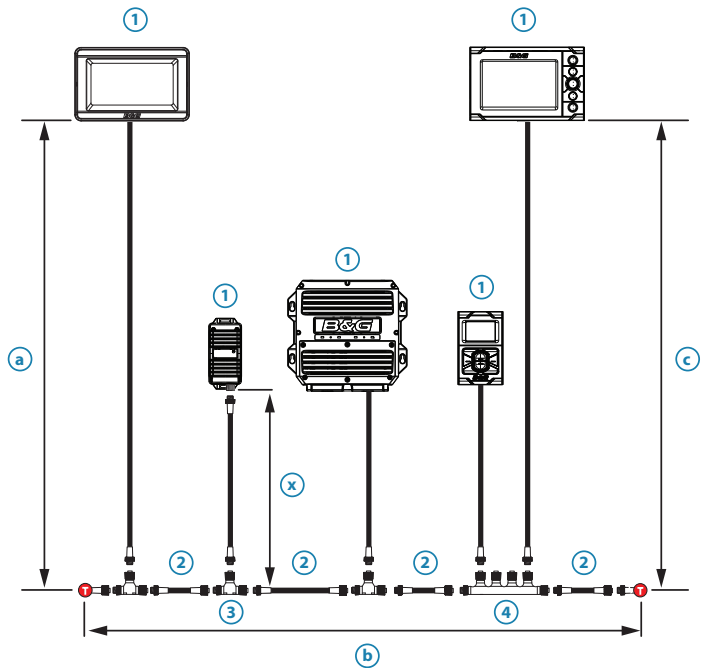

No.	Description	No.	Description
1	Network devices	3	Micro-CT-Joiner
2	Micro-C CAN bus backbone	4	Micro-C 4-way connector
T	Micro-C Terminator		

Bridged network

For networks that exceed the recommended network cabling maximum length a bridged network adaptor can be used.

→ **Note:** When using a network bridge it is important that both networks are powered and terminated as per H5000 network guidelines.

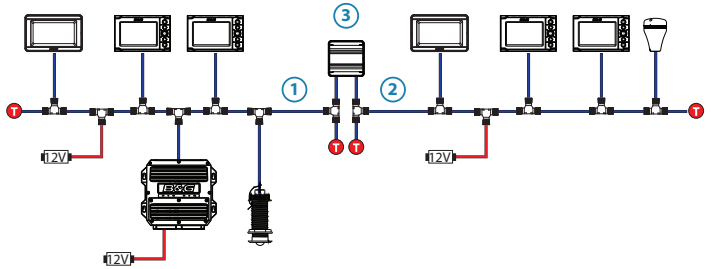

No.	Description	No.	Description
1	Micro-C CAN bus backbone 1	3	3rd party network bridge
2	Micro-C CAN bus backbone 2		
1	Micro-C Terminator	12V	12 Volt DC power supply

Network power supply

The H5000 network requires its own 12 V DC power supply protected by a 5 amp fuse or breaker. For 24 V systems, use a DC-DC converter to supply 12 V

Connect power at any location along the backbone for smaller systems.

For larger systems introduce power at central point in the backbone to balance the voltage drop of the network.

- **Note:** If joining to an existing Micro-C CAN bus backbone or similar CAN bus network that already has its own power supply, do not make another power connection.
- **Note:** Do not connect the Micro-C CAN bus power cable to the same battery as the start batteries, autopilot computer, radar, thruster or other high current devices.

The drawing below demonstrates a typical small network.

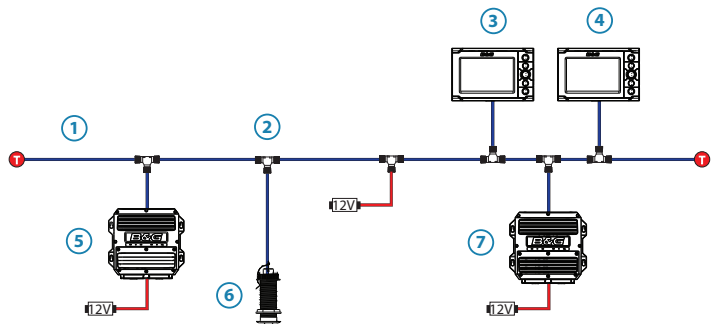

No.	Description	No.	Description
1	Network backbone	5	H5000 CPU
2	Micro-C T-Joiner	6	Sensor
3	Race display	7	H5000 Pilot Computer
4	Graphic Display		
T	Micro-C Terminator	12V	12 Volt DC power supply

5

H5000 Central Processor Unit - CPU

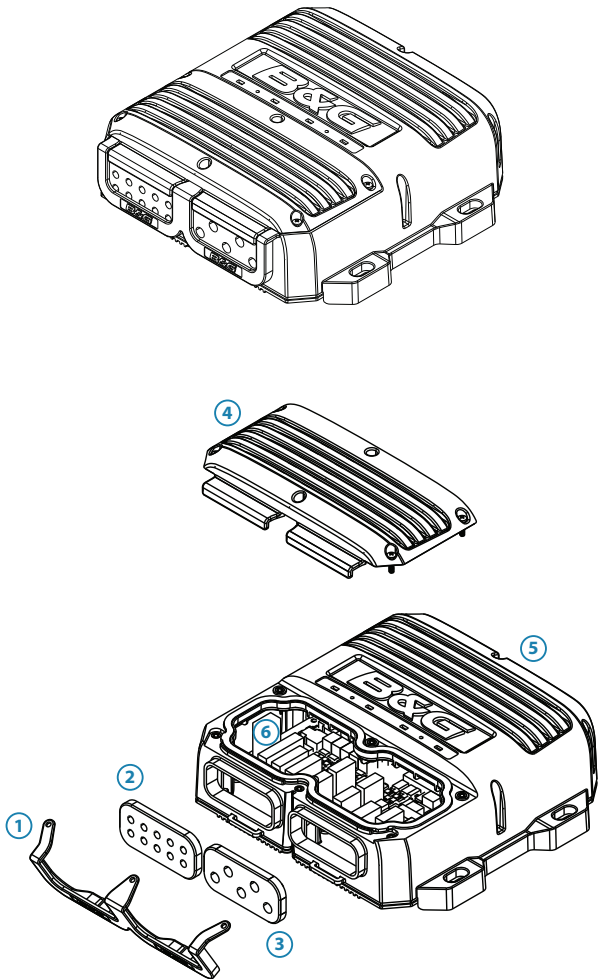

No.	Description	No.	Description
1	Grommet retaining clip	4	CPU lid with 6 x captive screws
2	10 hole cable grommet	5	CPU
3	5 hole cable grommet	6	CPU terminals

Status LEDs

On the top of the CPU there are 4 diagnostic / status LEDs. These LEDs will flash or change color to indicate system status as detailed in the table below



LED	STATUS	DESCRIPTION
POWER	No light	No power
	Solid green	Power on
	Solid red	Voltage too high or too low
NETWORK	No light or not flashing	No data being received or transmitted
	Flashing green	Data being transmitted
	Solid red	Network not in use or hardware error
USB	No light	Default state when not in use
	Flashing green	Software upgrade in progress
	Solid green	Software upgrade successful
	Solid red	Software upgrade failed
ETHERNET	Flashing green	Data being transmitted

CPU Installation

- 1: Find a suitable location to position the CPU.
- 2: Mount the CPU vertically. Ensure that there is at least 100 mm clearance between the cable grommet and any surface to enable easy access to cables.
- 3: Mark the hole positions, drill pilot holes and fix into position with four self tapping screws.
- 4: To remove the lid, unscrew the 6 captive lid screws anti-clockwise.

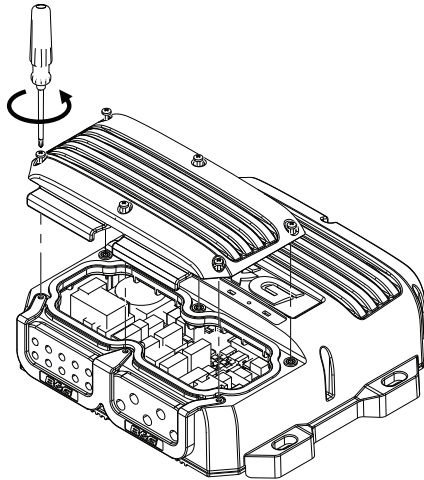

Note: The lid comes away from the CPU. The 6 captive screws remain fixed to the lid.

- 5: Remove the grommet retaining clip
- 6: Remove the cable grommet
- 7: Feed the cut cable through the cable grommet.

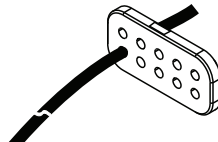

Note: Do not attach the terminal plug until the cable has been fed through the cable grommet! Ensure the grommet is orientated in the correct direction!

8: Wire the terminal plug as per the wiring instructions

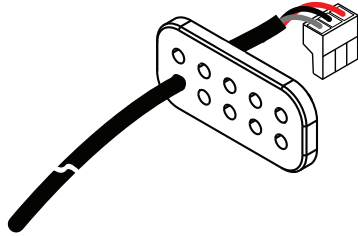

9: Press the cable grommet back into place ensuring there is sufficient cable for the plug to reach the correct terminal.

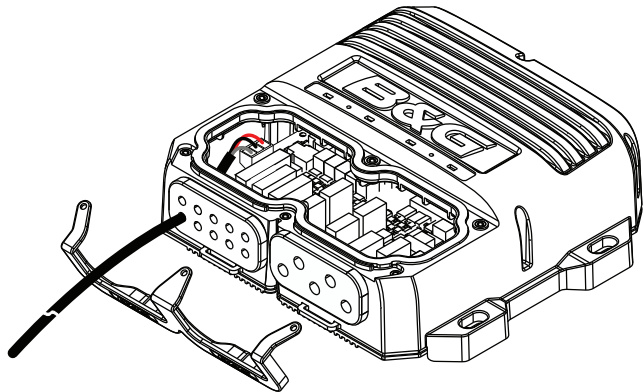

Note: Do not attach the terminal plug until the cable has been fed through the cable grommet!

10: Replace the grommet retaining clip.

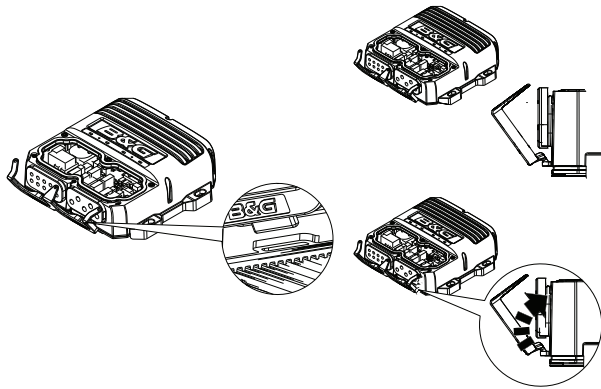

11: Example of a basic CPU wired unit shown below.

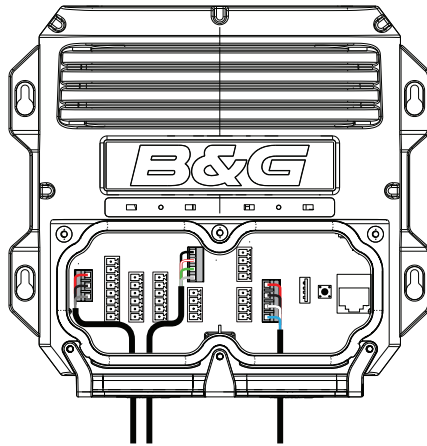

12: Before replacing the lid ensure that the grommet and retaining clip are fitted correctly. The lid will then clamp everything in place. Tighten the 6 captive lid screws clockwise.

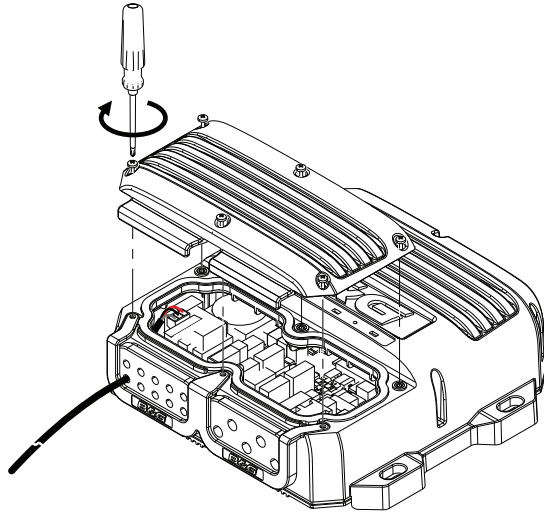

H5000 Central Processor wiring

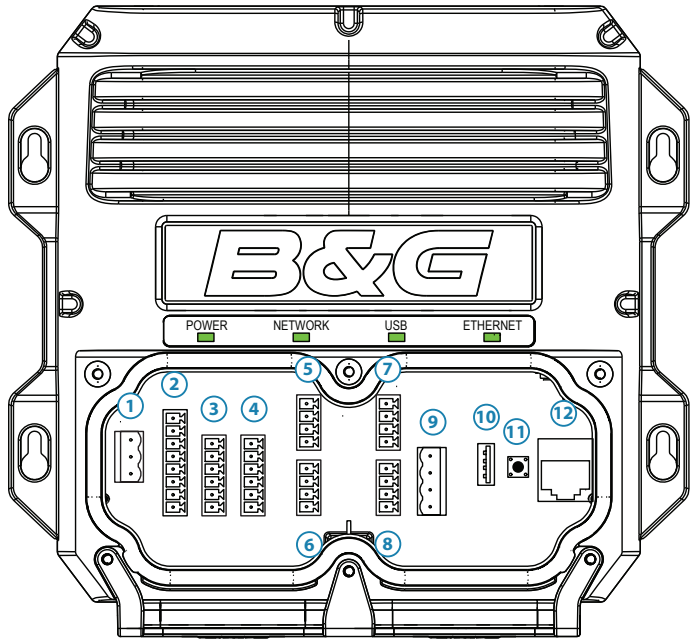

Connector layout

No.	Description	No.	Description
1	Power - 12 Volts	7	NMEA 0183 - Channel 2
2	Masthead unit	8	NMEA 0183 - Channel 1
3	Analog - Inputs 3 & 4	9	Network (NMEA 2000 compatible)
4	Analog - Inputs 1 & 2	10	USB port
5	Pulse input	11	Reset button
6	Man Overboard and Alarm	12	Ethernet (Webserver)

→ **Note:** There is a connection diagram on the inside of the processor lid.

Power supply

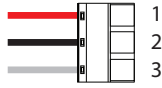
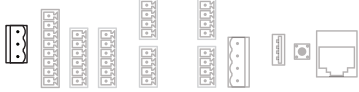
	Color	Description
1	Red	12 Volts
2	Black	0 Volts
3	-	Screen

Masthead Unit



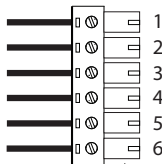
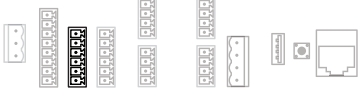

	Color	Description
1	Black	0 Volts
2	Orange	12 Volts
3	-	-
4	Red	Wind angle phase
5	Green	Wind angle phase
6	Blue	Wind angle phase
7	Violet	Wind speed
8	-	Screen (if present)

Analog input 3 & 4

	Color	Description
1	Sensor Dependent	0 Volts
2	Sensor Dependent	12 Volts
3	Sensor Dependent	5 Volts
4	Sensor Dependent	0 - 5 Volts (Analog 4)
5	Sensor Dependent	0 - 5 Volts (Analog 3)
6	-	Screen

Analog input 1 & 2

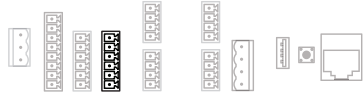
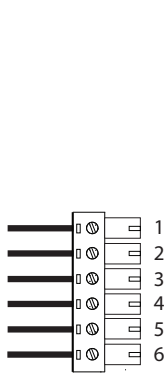

	Color	Description
1	Sensor Dependent	0 Volts
2	Sensor Dependent	12 Volts
3	Sensor Dependent	5 Volts
4	Sensor Dependent	0 - 5 Volts (Analog 2)
5	Sensor Dependent	0 - 5 Volts (Analog 1)
6	-	Screen

Pulse (Paddlewheel - Speed)

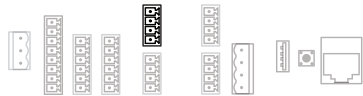
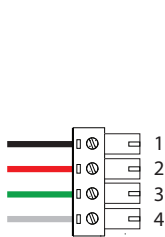

	Color	Description
1	Black	0 Volts
2	Red	5 Volts
3	Green	Pulse
4	-	Screen

Man Overboard Button input

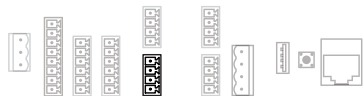
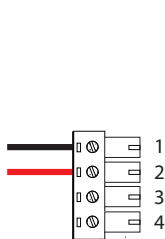

	Color	Description
1	Black	Send
2	Red	Return
3	-	-
4	-	-

Digital output (Alarm)

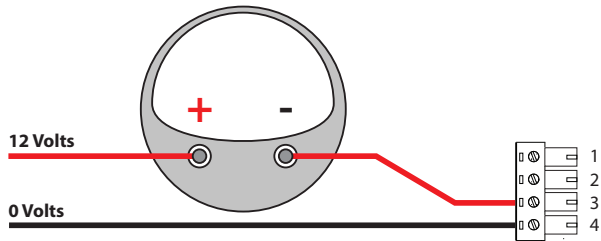
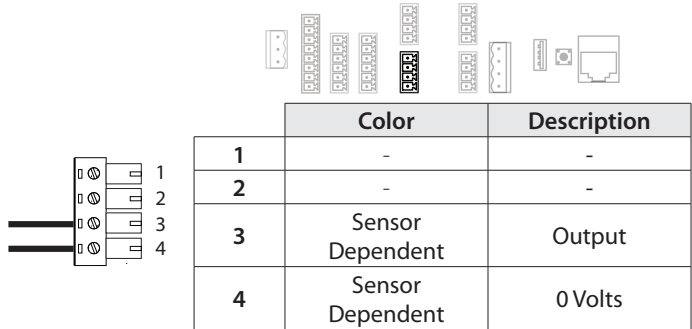

NMEA 0183 - Channel 2

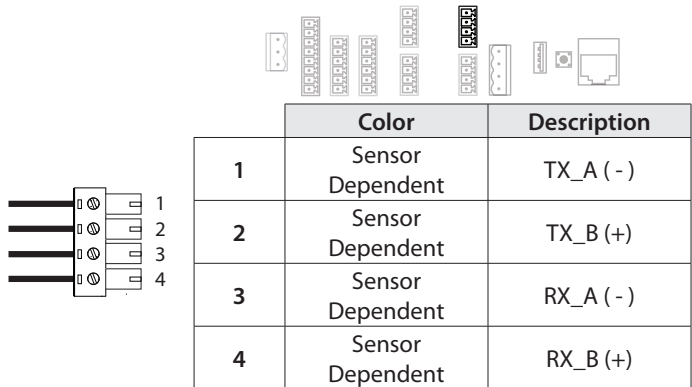

NMEA 0183 - Channel 1

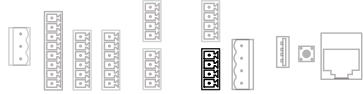
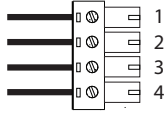

	Color	Description
1	Sensor Dependent	TX_A (-)
2	Sensor Dependent	TX_B (+)
3	Sensor Dependent	RX_A (-)
4	Sensor Dependent	RX_B (+)

Network (NMEA 2000 compatible)



	Color	Description
1	Red	12 Volts
2	Black	0 Volts
3	White	Data high +ve
4	Blue	Data low -ve

USB update port

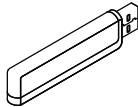

The USB port is used for software upgrades only. For further information follow the software upgrade procedure in the maintenance section of this manual.

Reset button



- Single press of the reset button whilst the system is powered up will initiate a reboot and soft reset of the CPU without cycling the power.
- A long press of the reset button whilst powering up the CPU will initiate a full factory reset.

→ **Note:** Performing a factory reset will revert all CPU settings to their default factory settings.

Ethernet port

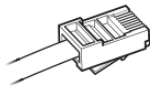

Ethernet port. Direct connection to a computer or WiFi router. Use the Webserver to access the CPU advanced calibration, set-up and diagnostics. Port can use standard or crossover cables.

Webserver

Connections

Direct via Ethernet

Connect a computer directly to the CPU via an ethernet cable.

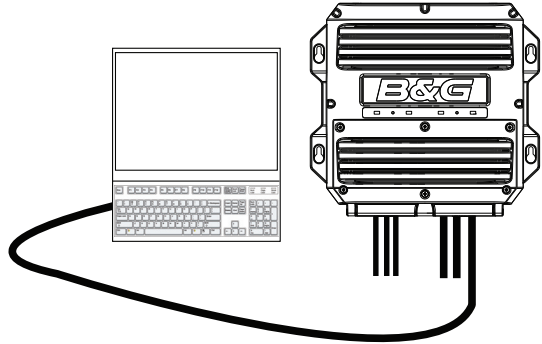

Wireless via a WiFi-1 router

Connect wireless devices to the CPU via a WiFi-1

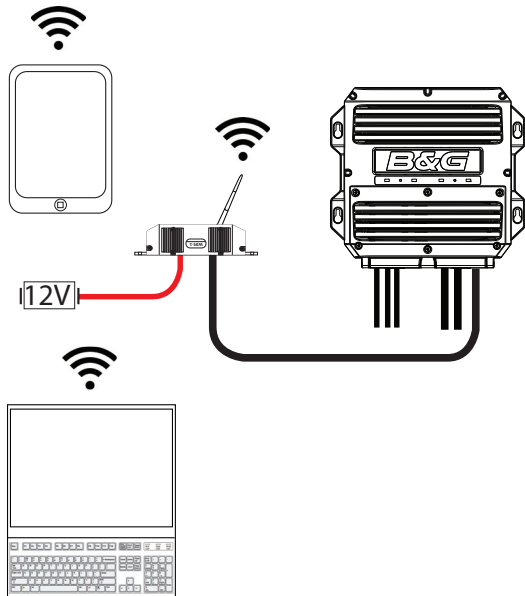

→ **Note:** To connect the WiFi-1 router to the H5000 CPU an Ethernet to RJ45 converter cable is required.

Accessing the webservice

An up to date web browser that supports web sockets must be used to access the B&G H5000 Webservice.

Via Ethernet

- 1 Connect device to the CPU (as shown previously).
 - 2 Open web browser on the connected computer or device.
 - 3 Type the IP address [192.168.0.2] into the web browser address bar
- **Note:** Unit will attempt to select a DHCP server for 2 minutes after power on. If the server is not detected the unit will revert to IP address [192.168.0.2]
- 4 Once connected correctly the B&G H5000 Webservice home screen will appear.
- **Note:** It will say “Websocket: Connected” in the top right-hand corner of the screen next to the help tab. If it says “Websocket: Not Connected” then check the CPU and router power and connections.



Via wireless WiFi-1 router

- 1 Connect device to the CPU (as shown previously).
 - 2 Open web browser on the connected computer or device.
 - 3 Find the IP address of the CPU via a Graphic Display.
- **Note** The CPU IP address can be found via the Graphic displays system network menu under CPU info. Make a note of this IP address.
- 4 Type the CPU IP address into the web browser address bar
- **Note:** Unit will attempt to select a DHCP server for 2 minutes after power on. If the server is not detected the unit will revert to IP address [192.168.0.2]
- 5 Once connected correctly the B&G H5000 Webservice home screen will appear.

6

Expansion Modules

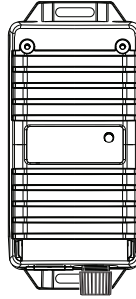

1: Find a suitable location for the module.

Mount the module vertically. Ensure that there is at least 100 mm clearance between the connector and grommet and any surface to enable easy access to cables

2: Mark the hole positions, drill pilot holes and fix into position with two self tapping screws

3: To remove the lid, unscrew the two lid screws.

Note: The lid hinges at the bottom edge of the module. To close the lid you need to locate the bottom edge first.

4: Cut the grommet indicated to a length that creates a tight fit for the cable to be fed. Feed the cable through and wire into the module plug.

Ensure the cables are positioned to the left of the centre pillar and the plug can reach the connectors without placing tension on the wires.

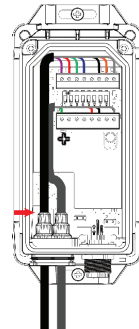
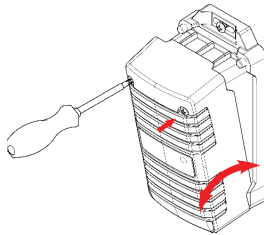

H5000 Expansion Module wiring

The Analog and Serial Expansion Module connector terminals have differing functions. Below is a list of the connectors their terminal numbers and their functions.

→ **Note:** The functions of individual ports on the Expansion Modules are set via the webserver interface.

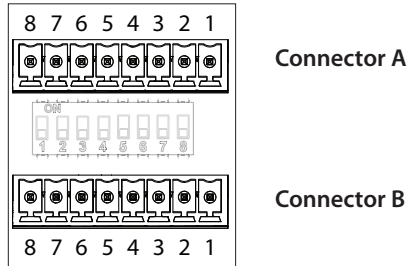

Analog Expansion Module		
Terminal	Connector A	Connector B
1	Screen	Screen
2	12 V	12 V
3	0 V	0 V
4	5 V	5 V
5	0 - 5 V input	0 - 5 V input
6	0 - 5 V input	0 - 5 V input
7	0 - 5 V input	0 - 5 V input
8	Pulse 1	Pulse 2

Serial Expansion Module		
Terminal	Connector A	Connector B
1	Screen	Screen
2	5 V	12 V
3	0 V	0 V
4	Digital I/O	Digital I/O
5	A (TX +)	A (TX +)
6	B (TX -)	B (TX -)
7	A (RX +)	A (RX +)
8	B (RX -)	B (RX -)

H5000 Expansion Module wiring example

Below is an example of how to wire an Analog module with a masthead unit and paddle wheel sensor.

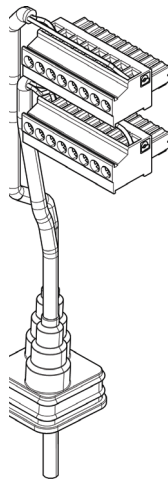

Masthead Unit

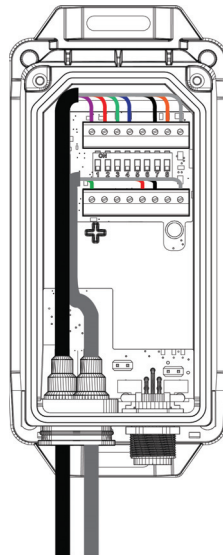

Paddle Wheel Sensor

Masthead Unit

- 1 Screen
- 2 Orange
- 3 Black
- 4 -
- 5 Blue
- 6 Green
- 7 Red
- 8 Violet

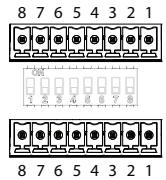

Paddle Wheel Sensor

- 1 Screen
- 2 -
- 3 Black
- 4 Red
- 5 -
- 6 -
- 7 -
- 8 Green

Module Jumpers

If a sensor or combination of sensors connected to an analog or Serial Expansion Module draw more than 300 mA current total, then a terminal link must be placed onto both jumpers located above the network connector, inside the module as shown below. This bypasses the isolated power supply within the module.

→ **Note:** Do not bypass the isolated power supply unless necessary

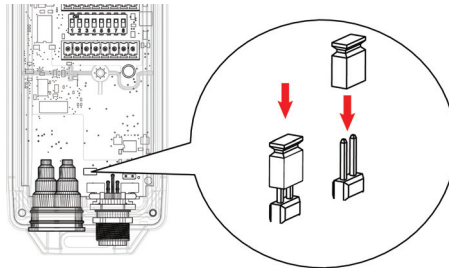

7

External sensor wiring Analog Expansion

Masthead unit

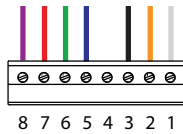

	Color	Input
1	-	Screen
2	Orange	12 Volts
3	Black	0 Volts
4	-	-
5	Blue	Wind Angle Phase
6	Green	Wind Angle Phase
7	Red	Wind Angle Phase
8	Violet	Wind Speed

5 V Analog input / 0 V to +5 V signal

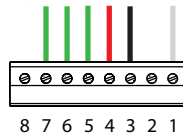

CONNECTOR A (TOP TERMINALS)			
	Color	Input	Channel
1	-	Screen	-
2	-	-	-
3	Black	0 Volts	-
4	Red	5 Volts	-
5	Sensor dependent	Signal 0 V to +5 V	Analog 1
6	Sensor dependent	Signal 0 V to +5 V	Analog 2
7	Sensor dependent	Signal 0 V to +5 V	Analog 3
8	-	-	-

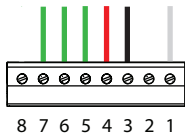

CONNECTOR B (BOTTOM TERMINALS)			
	Color	Input	Channel
1	-	Screen	-
2	-	-	-
3	Black	0 Volts	-
4	Red	5 Volts	-
5	Sensor dependent	Signal 0 V to +5 V	Analog 4
6	Sensor dependent	Signal 0 V to +5 V	Analog 5
7	Sensor dependent	Signal 0 V to +5 V	Analog 6
8	-	-	-

→ **Note:** 0 Volt to 5 Volt sensors can be wired into either Connector A or Connector B. If you plug a 0 - 5 Volt analog input into connector 1 then the analog channels will be 1, 2 & 3, if connected to connector 2 then they will be channels 4, 5 & 6.

Paddle wheel

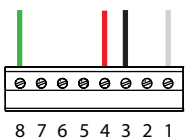

	Color	Input
1	-	Screen
2	-	-
3	Black	0 Volts
4	Red	5 Volts
5	-	-
6	-	-
7	-	-
8	Green	Speed

Paddle wheel & Sea temperature

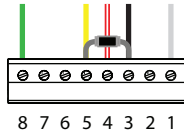

	Color	Input
1	-	Screen
2	-	-
3	Black	0 Volts
4	Red & White	5 Volts
5	Yellow	Sea Temperature
6	-	-
7	-	-
8	Green	Speed

→ **Note:** 10 K ohm resistor required between terminal 5 and 3

8

External sensor wiring Serial Expansion

NMEA 0183 - GPS Antenna

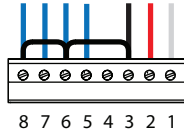

	Color	Input
1	-	Screen
2	Red	12 Volts
3	Black	0 Volts
4	-	-
5	Sensor Dependent	TX_A (+)
6	Sensor Dependent	TX_B (-)
7	Sensor Dependent	RX_A (+)
8	Sensor Dependent	RX_B (-)

→ **Note:** A link wire may be required (as shown) between terminals 3 & 6 and 6 & 8 depending on the sensor.

Halcyon Gyro Stabilized Compass - HGSC

→ **Note:** Fit the module jumper as previously described to bypass the isolated power supply

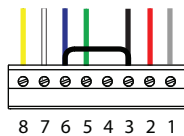

CONNECTOR B (BOTTOM TERMINALS)		
	Color	Input
1	-	Screen
2	Red	12 Volts
3	Black	0 Volts
4	-	-
5	Green	HGSC Data out +
6	Blue	HGSC Data out -
7	White	HGSC Data in +
8	Yellow	HGSC Data in -

→ **Note:** A link wire is required between terminals 3 & 6

9

Sensor Modules

There are three types of Sensor Module, Barometer, 3D Motion Sensor and Network Alarm.

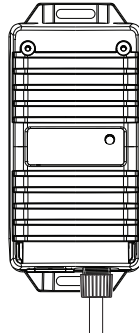

1: Find a suitable location for the module.

Mount the module vertically. Ensure that there is at least 100 mm clearance between the connector and grommet and any surface to enable easy access to cables

2: Mark the hole positions, drill pilot holes and fix into position with two self tapping screws

→ **Note:** If installing a 3D Motion Sensor ensure that it is installed vertically and facing forwards towards the bow of the boat as shown below.

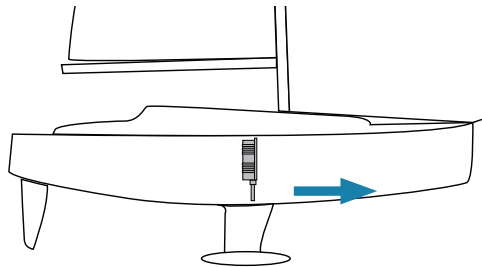

10

Autopilot

H5000 Pilot Computer

General

The H5000 Pilot Computer is mounted as per the CPU instructions.

- **Note:** When the autopilot installation is completed, the system must be configured and the commissioning procedures performed. Failure in setting up the autopilot correctly may prohibit the autopilot from functioning properly.

Wiring

Access the terminals by removing the 6 captive screws in the H5000 Pilot Computer lid. Follow the same method as described for the CPU.

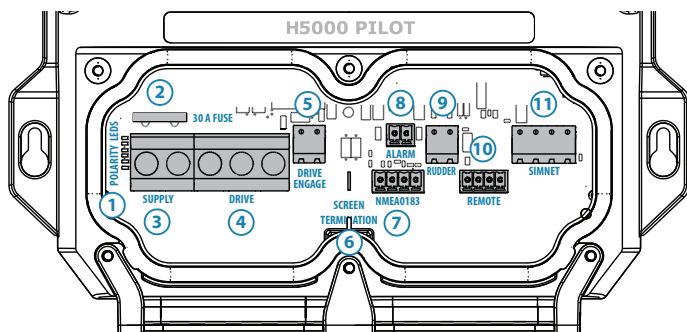

Connector layout

No.	Description	No.	Description
1	Polarity LEDs	7	NMEA 0183
2	30 Amp fuse	8	Alarm
3	Power supply 12 or 24 Volts	9	Rudder
4	Drive output	10	Remote
5	Drive Engage - Clutch	11	Network (NMEA 2000 compatible)
6	Screen Termination		

Power



Direct	Color	Description
1	Red	12 or 24 Volts
2	Black	0 Volts

→ **Note:** The power cable is hard wired directly to the supply terminal on the PCB.

Drive

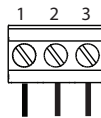

Direct	Color	Description
1	Drive Dependant	Motor / Solenoid 1
2	Drive Dependant	Motor / Solenoid 2
3	Drive Dependant	Solenoid ground

→ **Note:** The drive cable is hard wired directly to the drive terminal on the PCB.

Reversing drive

Hydraulic drives and rotary drives need connection to the Engage terminal for clutch operation.

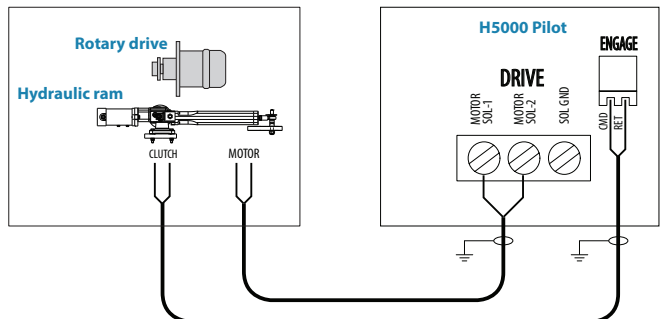

Solenoid valves, 12 V or 24 V DC

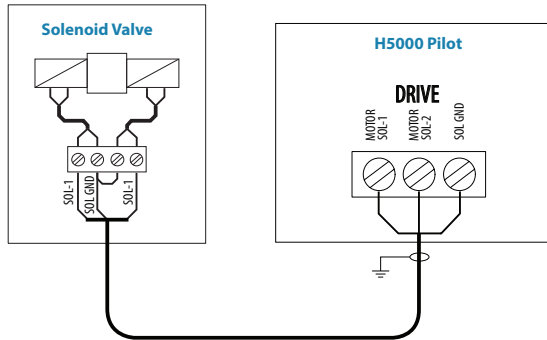

→ **Note:** For solenoids with higher voltage (110/220 V AC or DC), use external relays/solid state relays.

Engage (Clutch)



	Color	Description
1	Drive Dependant	Engage Command
2	Drive Dependant	Engage Return

Alarm

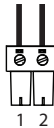

	Color	Description
1	Alarm Dependant	Input
2	Alarm Dependant	Return

NMEA 0183

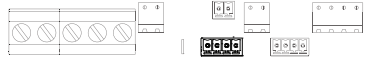
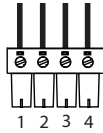

	Color	Description
1	Sensor Dependent	RX_B
2	Sensor Dependent	RX_A
3	Sensor Dependent	TX_B
4	Sensor Dependent	TX_A

Rudder

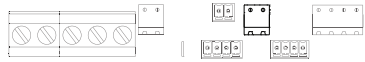

	Color	Description
1	Brown	Frequency +
2	Grey	Frequency -

Remote

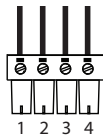

	Color	Description
1	Remote Dependant	Lamp
2	Remote Dependant	Starboard
3	Remote Dependant	Port
4	Remote Dependant	Ground

Simnet (Network)

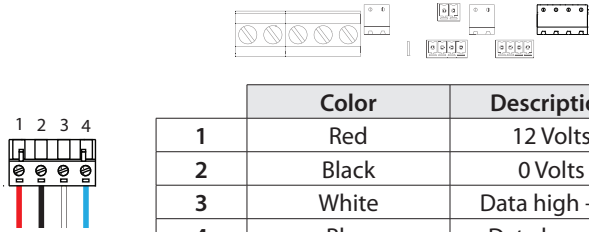

Turning on for the first time

Before attempting to turn on the autopilot and perform an installation setup, the hardware installation and electrical installation must be completed and in accordance with the installation instructions.

The first time the autopilot system is started and after a factory reset, you will need to follow the setup and commissioning procedures as described.

→ **Note:** Some important points regarding the installation settings:

- When the autopilot is delivered from factory and ANY TIME AFTER AN AUTOPILOT RESET HAS BEEN PERFORMED, the installation settings are all reset to factory preset (default) values.
- The prompt will appear and a complete setup has to be made.
- The Sea Trial settings are dependent on successful completion of the Dockside settings.

H5000 Pilot Controller

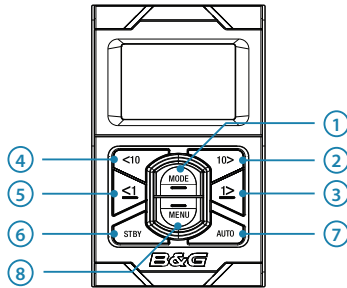

Keys

The H5000 Pilot Controller is operated by 8 keys. These are used to operate the autopilot and adjust autopilot parameters.

1 MODE

Change the autopilot mode / Scrolls up in menu options / Increases values. With active autopilot: Toggles between Wind mode and Auto mode. Press and hold for further functions.

2 10° COURSE CONTROL STARBOARD

Change target course 10° Starboard / Activates Non Follow Up (NFU) mode when in Standby mode

3 1° COURSE CONTROL STARBOARD

Change target course 1° Starboard / Activates Non Follow Up (NFU) mode when in Standby mode / Enter menu

4 10° COURSE CONTROL PORT

Change target course 10° Port / Activates Non Follow Up (NFU) mode when in Standby mode

5 1° COURSE CONTROL PORT

Change target course 1° Port / Activates Non Follow Up (NFU) mode when in Standby mode / Exit menu

6 STBY

Disengage the autopilot

7 AUTO

Engage the autopilot

8 MENU

Enter the main menu / Scrolls down in the menu options / Decreases values. Press and hold for 3 secs enters the lighting settings

Connectors

The H5000 Pilot Controller is equipped with 1 Micro-C flying lead..

Network

The H5000 Pilot Controller can be connected at any point on the network.

→ **Note:** The H5000 Pilot Controller is only compatible with the B&G H5000 Pilot.

11

Commissioning

If an H5000 Pilot Computer and H5000 Pilot Controller are connected to the network then autopilot control and setup functionality can be accessed via the H5000 Pilot Controller.

▲ Warning: The installation settings must be performed as part of the commissioning of the autopilot system. Failure to do so correctly may prohibit the autopilot from functioning properly! The Installation menu can only be accessed in Standby mode.

Dockside

The dockside procedures are initiated from the commissioning dialog via the H5000 Pilot Controller.

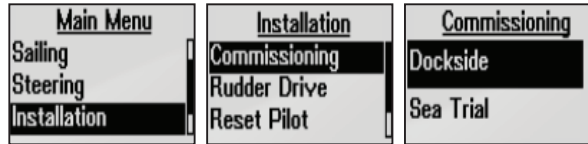

Boat length

Set the boat length of the vessel.

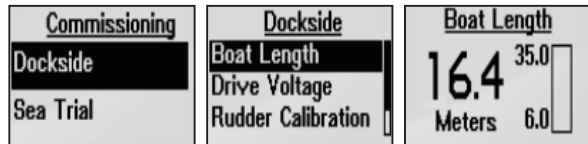

Drive voltage (V)

Set the drive voltage type to 12 or 24 V

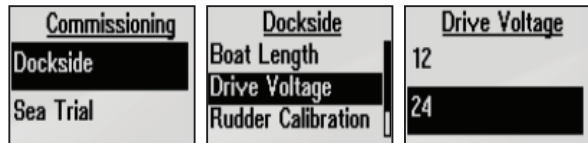

Rudder calibration

Make sure the Rudder Feedback unit is installed and aligned as per your Rudder Feedback installation manual. The rudder feedback calibration will set the correct relationship between the physical rudder movement and the rudder angle readout.

Commissioning	Dockside	Rudder Calibration
Dockside	Boat Length	Turn Rudder to Max Starboard.
Sea Trial	Drive Voltage	00
	Rudder Calibration	



Max starboard

The Max starboard angle is the angle read by the rudder feedback unit before any adjustment is made.

- 1 Manually move the helm to starboard until the rudder stops at starboard lock hard over. Press **1° Starboard** key to confirm.
- 2 If the actual rudder angle is different from the angle displayed, correct the reading with the **Up/Down** keys.
- 3 Confirm Rudder feedback calibration to starboard by pressing **1° Starboard** key.

Rudder Calibration	Rudder Calibration	Rudder Calibration
Turn Rudder to Max Starboard.	Enter max angle	Enter max angle
00	45	43
	43	43



Max port

The Max starboard angle is the angle read by the rudder feedback unit before any adjustment is made.

- 1 Manually move the helm to port until the rudder stops at port lock hard over. Press **1° Starboard** key to confirm.
- 2 Adjust the displayed angle the same way as for starboard rudder.
- 3 Confirm Rudder feedback calibration to port by pressing **1° Starboard** key.

➔ **Note:** Many boats have $\pm 45^\circ$ (90° H.O. - H.O.) rudder angle as standard. So if you are not going to make any adjustment to the displayed angle you should still highlight the reading and confirm. This is necessary to prevent the rudder from hitting the end stops.

Rudder Calibration	Rudder Calibration	Rudder Calibration
Turn Rudder to Max port.	Enter max angle	Center the Rudder.
43	45	45
	45	45

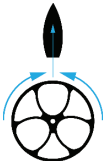

Set Rudder mid point

Bring the rudder to midship position and press 1° Starboard key to confirm. This will adjust any incorrect reading caused by misalignment of the rudder feedback unit.

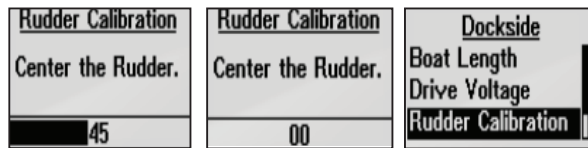

Rudder drive settings

Ensure that the rudder information is set correctly before you continue with the Dockside commissioning.

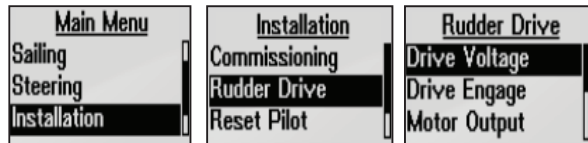

Drive voltage (V)

Sets the drive voltage to the type installed on the vessel, 12 or 24 V.

Drive engage

Drive engage has the following settings: Auto and Clutch.

Auto:

This setting is implemented for future use. Always use the Clutch (default) setting.

Clutch:

This is the default setting and it allows you to steer the boat from the helm when in Standby mode. A clutch will be engaged on the drive unit locking out the steering when the autopilot is engaged.

Motor output

The Motor output (displayed as a percentage) is the amount of available power needed to achieve correct rudder speed on automatic steering (Maximum speed is used in NFU mode). This setting will allow you to adjust the rudder speed to be different from the one automatically set in the rudder test.

Rudder deadband

The rudder deadband function is adaptive and is continuously updating. It prevents the rudder from hunting and the adaptive function optimizes the deadband to the speed of the boat and the load on the rudder.

If the auto-setting does not perform properly due to high inertia from the wheel, it can be adjusted manually.

Find the lowest possible value that will prevent the rudder from continuous hunting. A wide deadband will cause inaccurate steering. It is recommended to check rudder stability in Auto mode when the boat is moving to get pressure on the rudder.

Rudder feedback

Set the rudder feedback type from the available options

Rudder Test

→ **Note:** If the boat uses power assisted steering, it is important that the engine or electric motor used to enable the power assist steering be turned on prior to this test.

▲ **Warning:** Stand CLEAR of the wheel and do not attempt to take manual control of the wheel during this test!

Bring the rudder manually to midship position before starting the test.

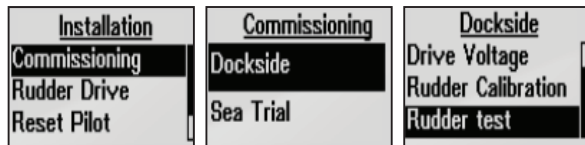

After a few seconds the H5000 Pilot Computer will issue a series of port and starboard rudder commands and automatically verify correct rudder direction.

It detects minimum power to drive the rudder and reduces the rudder speed if it exceeds the maximum preferred speed (8°/sec.) for autopilot operation.

The Rudder test is verified by the display showing Completed Rev. motor, Completed Solenoids, or Failed. If Failed is displayed, check for correct electrical connection.

Autotune

▲ Warning: Autotune must always be performed in open waters at a safe distance from other traffic. The Automatic tuning function may take from 2 to 3 minutes to complete. To stop the Autotune at any time, press the **STBY** key.

Autotune is a feature that automatically sets the most important steering parameters (Rudder and Counter Rudder) by taking the boat through a number of S-turns. The scaling factors of the parameters are also set automatically as a function of the boat type selection performed in the Dockside menu.

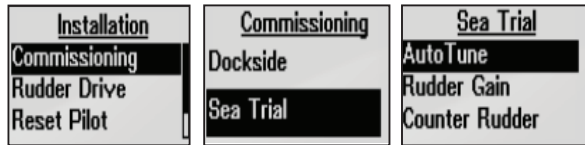

The automatic tuning process is also verifying/adjusting the Rudder zero alignment made in Dockside setup.

Recommended speed during Auto Tune should not exceed 10 knots. It should be performed in calm or moderate sea conditions. For displacement boats use a speed that is approximately half the normal cruising speed (i.e. if cruising speed is 10 knots, perform the Autotune at about 5 knots).

Select Autotune to begin the tuning process. Press **1° RIGHT** to confirm Autotune.

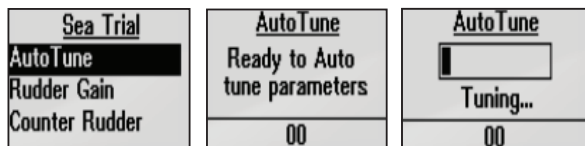

After the Autotune has been completed the rudder must be controlled manually, as the autopilot has returned to Standby mode.

Once complete the screen will display the word finished and there should be no need for further adjustments. Fine tuning of these parameters are made by the response control, however, viewing or changing the parameters can be made in Auto mode by entering Installation in the Main menu.

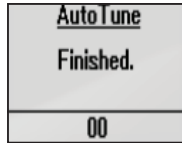

Rudder gain

Sets the rudder gain which is the ratio between the commanded angle and the heading error.

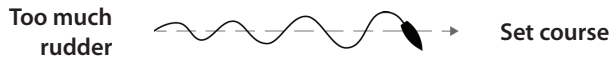

- Too little Rudder gain and the autopilot fails to keep a steady course
- Too much Rudder gain gives unstable steering and reduces speed
- Low speed requires more rudder gain than high speed

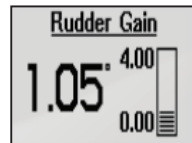
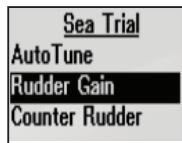
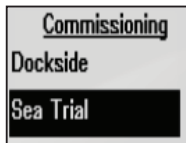

Counter rudder

Counter Rudder is the parameter that counteracts the effect of the boat's turn rate and inertia. For a short time period it is superimposed

on the proportional rudder response caused by the heading error. It may sometimes appear as if it tends to make the rudder move to the wrong side (counter rudder).

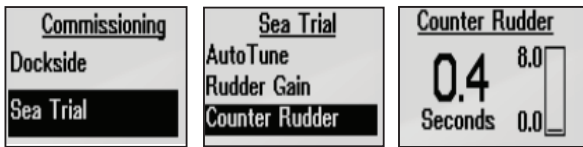

The best way of checking the value of the Counter Rudder setting is when making turns. The figures illustrate the effects of various Counter Rudder settings.

Counter rudder setting too low = Overshoot response

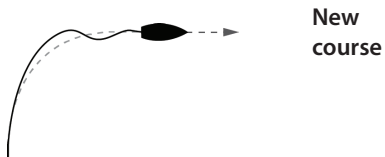

Counter rudder setting too high = Sluggish and creeping response

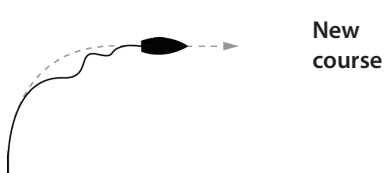

Correct setting of counter rudder, ideal response

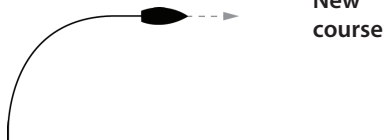

Sea trial

After completing the autopilot calibration and all settings in the installation menu, you will need to perform a final sea trial.

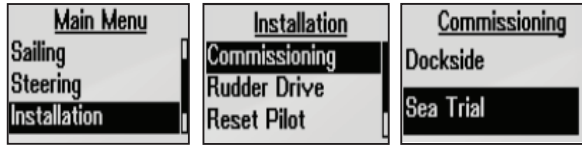

→ **Note:** The sea trial should be conducted in open waters at a safe distance from other traffic.

- Steer the boat on all cardinal headings in Auto mode
- Start with low and medium speeds to get familiar with the response from the autopilot
- Check the effect of the Response adjust
- Set waypoints into each navigator connected to the system, and verify that the autopilot steers in Navigation mode for each Navigation source
- Use the Wind mode in both Apparent and True modes and engage the autopilot at different wind angles.
- If the rudder response feels aggressive during the sea trial, try to reduce the rudder speed to get smoother steering. Use a higher rudder speed when running downwind.
- The motor Drive Out can be set with the above in mind. Never adjust in more than 10% steps with respect to the reading set during the automatic rudder test. Always perform a new Autotune after the adjustment.

12

Maintenance

General maintenance

The instruments are not user repairable and the operator is therefore required to perform only a very limited amount of preventive maintenance.

If the unit requires any form of cleaning, use fresh water and a mild soap solution (not a detergent). It is important to avoid using chemical cleaners, alcohols and hydrocarbons such as diesel, petrol etc. Always put on the weather cover when the unit is not in use.

Checking the keys

Make sure that no keys are stuck in the down position.

Checking the connectors

The connectors should be checked by visual inspection only. Ensure that cables are connected correctly and any unused terminals are protected.

Software upgrade

To find out the latest version of software available for your device go to the B&G website www.bandg.com

Software upgrade

H5000 CPU

To upgrade the CPU software to the latest version, save the .upd file (upgrade file) to a USB memory stick. (Must be FAT or FAT32 format, NTFS is not supported)

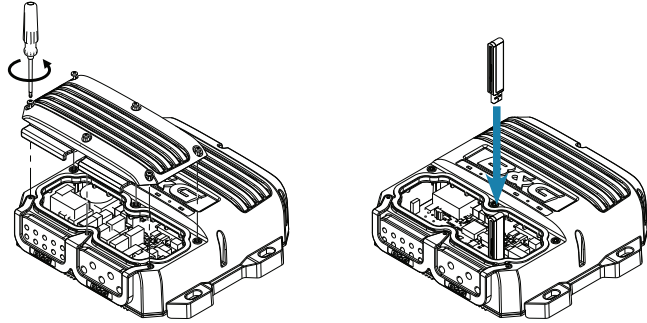

- 1 Save .upd file to a USB Stick. (Must be in the root folder and not a subfolder)
 - 2 Turn off power to the CPU
 - 3 Remove the CPU lid
 - 4 Insert USB stick into the USB port
 - 5 Turn on power to the CPU
 - 6 The CPU will automatically recognise the .upd file and begin the upgrade process
 - 7 To indicate the upgrade is in progress the USB LED on the top of the CPU will flash green
 - 8 When the USB LED turns solid green (stops flashing) the upgrade process is complete
 - 9 Remove the USB stick, the CPU will automatically reboot
- **Note:** A solid red light on the USB LED indicates the upgrade was unsuccessful. Check your .upd file and USB stick and repeat the process. If you continue to experience difficulties updating the software please seek assistance from a B&G specialist.

H5000 Pilot Computer / Pilot Controller

To upgrade the H5000 Pilot Computer or controller to the latest software version, use the Navico Software Upgrade Tool. Follow the Navico SWUP (Software Upgrade) tool or an MFD.

Graphic Display

To upgrade the Graphic Display software to the latest version save the .upd file (upgrade file) to a USB memory stick. (Must be FAT or FAT32 format, NTFS is not supported)

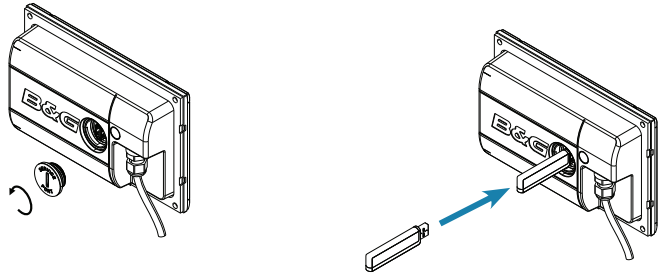

- 1 Save .upd file to a USB Stick (Must be in the root folder and not a subfolder)
- 2 Turn off power to the Graphic Display
- 3 Remove the service port cap on the rear of the display by unscrewing it anti-clockwise using a suitable coin
- 4 Place USB stick into the USB port
- 5 Turn on power to the Graphic Display
- 6 The display will automatically recognise the .upd file and begin the upgrade process
- 7 The display will show a message indicating the software upgrade is in progress
- 8 The display will show a message once the software upgrade is complete
- 9 Remove the USB stick, the Graphic Display will automatically reboot
- 10 Replace the service port cap

Race display

To upgrade the Race display to the latest software version use a MFD or Navico Software Upgrade Tool.

Analog / Serial expansion module

To upgrade Analog / Serial expansion modules to the latest software version use a MFD or the Navico Software Upgrade Tool.

Navico NMEA 2000 devices

To upgrade NMEA 2000 devices to the latest software version use a MFD or the Navico Software Upgrade Tool.

13

Technical drawings & specifications

H5000 Central Processor Unit - CPU

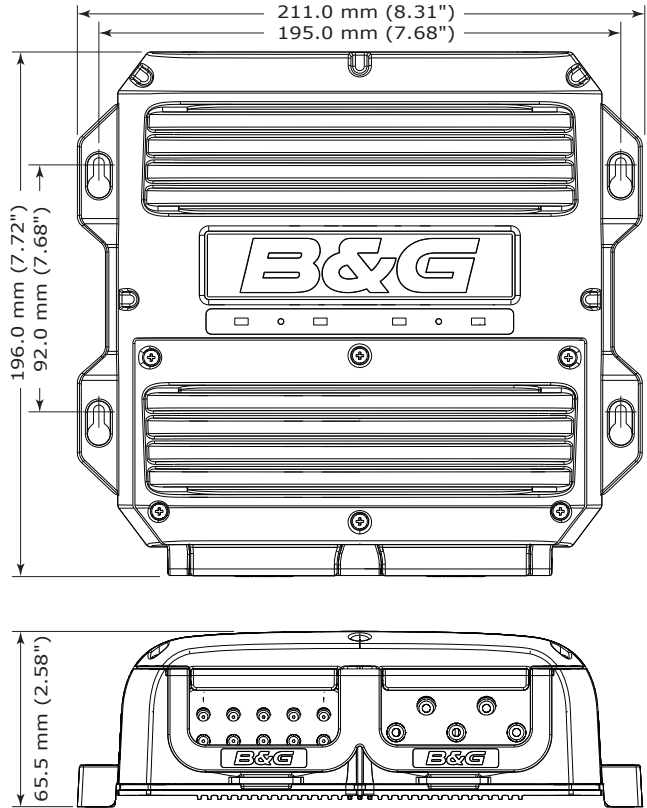

Weight	0.7 kg, 1.6 lbs
Supply voltage	12 V DC Nominal (9-16 V)
Power consumption	2.4 Watts (200 mA @ 12 V) Typical
Can bus power consumption	0.6 Watts (50 mA @ 12 V) Typical (NMEA 2000® equivalent 1 LEN)
Color	Black
Environmental Protection	IPX4
Safe distance to compass	0.3 m (1.0 ft.)

Graphic Display

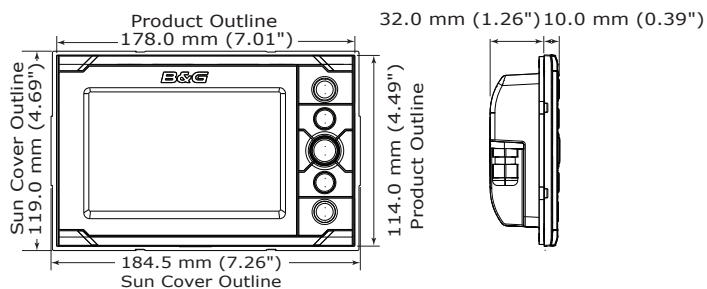

Weight	0.45 kg (1.0 lbs)
Supply voltage	12 V DC Nominal (9-16 V) Network powered
Power consumption	1.9 Watts (160 mA @ 12 V) Typical 2.3 Watts (190 mA @ 12 V) Max. (NMEA 2000® equivalent 3 LEN)
Color	Black
Display	
Size	5" (Diagonal) 4:3 Aspect ratio
Type	Transmissive TFT-LCD White LED back-light
Color	16-bit, high color
Resolution	480 x 272 pixels
Environmental Protection	IPX7
Safe distance to compass	0.3 m (1.0 ft.)

Race display

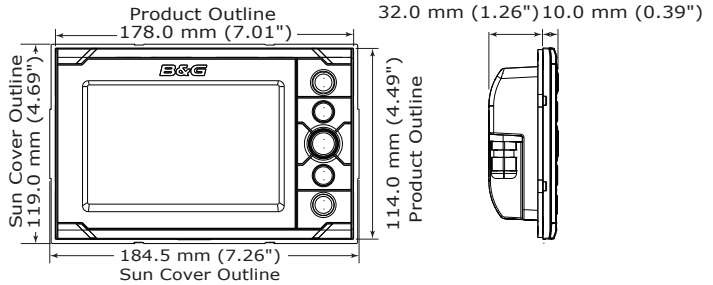

Weight	0.45 kg (1 lbs)
Supply voltage	12 V DC Nominal (9-16 V) Network powered
Power consumption	0.6 Watt (50 mA @ 12 V) Typical 1.0 Watts (86 mA @ 12 V) Max. (NMEA 2000® equivalent 2 LEN)
Color	Black
Display	
Size	5" (Diagonal)
Type	Transflective - 7 segment LCD White & Red LED back-light
Color	Monochrome
Resolution	7 segment LCD
Environmental Protection	IPX7
Safe distance to compass	0.3 m (1.0 ft.)

H5000 Pilot Computer

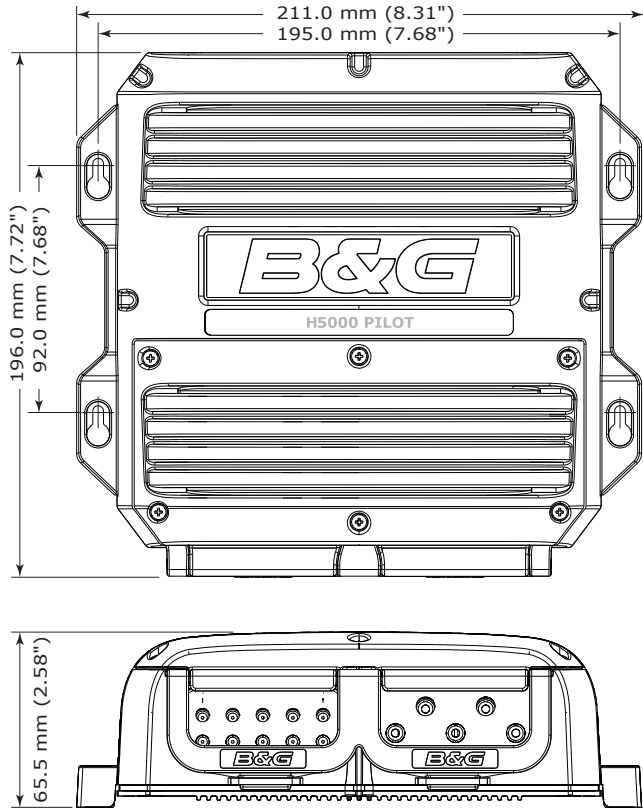

Weight	0.7 kg, 1.6 lbs
Supply voltage	12 V DC Nominal (9-16 V)
Power consumption	0.6 Watts (50 mA @ 12 V) Typical (NMEA 2000® equivalent 1 LEN)
Color	Black
Environmental Protection	IPX4
Safe distance to compass	0.3 m (1.0 ft.)

H5000 Pilot Controller

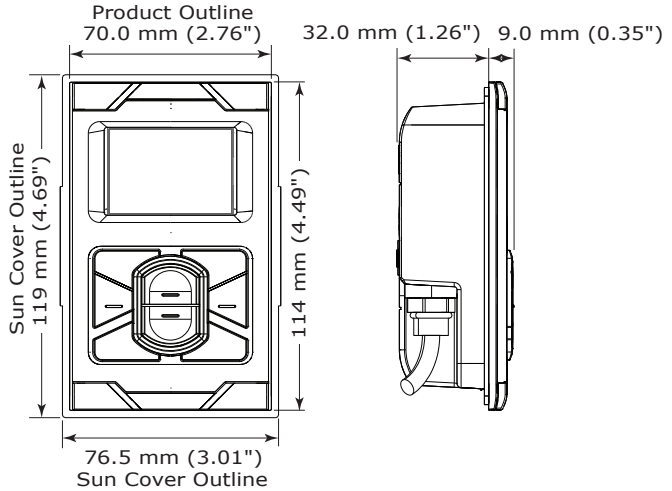

Weight	0.18 kg (0.4 lbs)
Power consumption	1.2 Watt (100 mA @ 12 V) Typical 1.6 Watts (130 mA @ 12 V) Max. (NMEA 2000® equivalent 3 LEN)
Color	Black
Display	
Size	2" (Diagonal)
Type	LED / Transflective
Color	Monochrome
Resolution	128 x 64 pixels
Environmental Protection	IPX7
Safe distance to compass	0.3 m (1.0 ft.)



B&G

www.bandg.com

