

DiscoveryTM 3300

METAL
DETECTOR
WITH SUPER-SCANTM

by **BOUNTY HUNTER[®]**

OWNER'S MANUAL

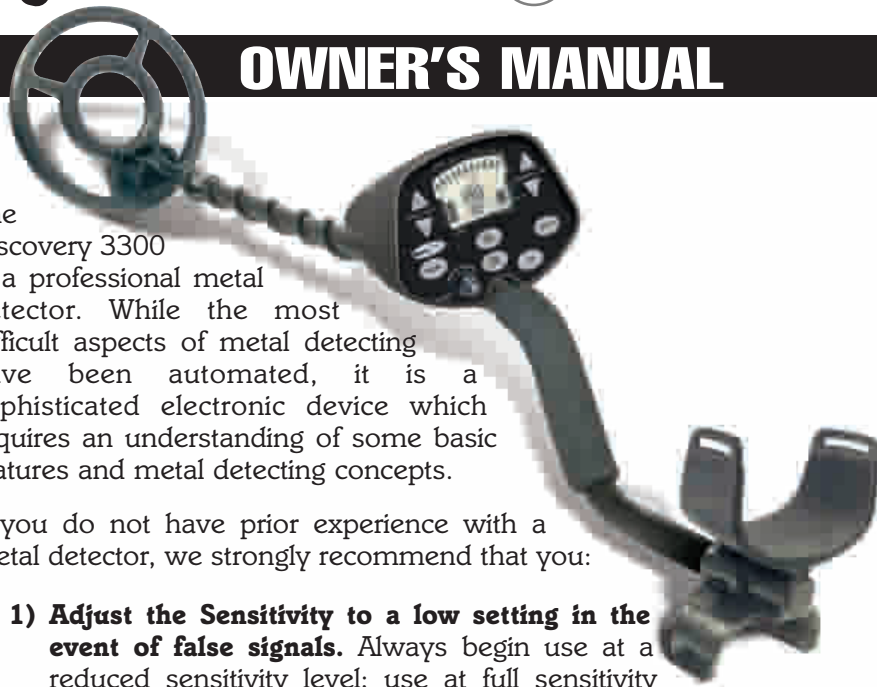

The Discovery 3300 is a professional metal detector. While the most difficult aspects of metal detecting have been automated, it is a sophisticated electronic device which requires an understanding of some basic features and metal detecting concepts.

If you do not have prior experience with a metal detector, we strongly recommend that you:

- 1) Adjust the Sensitivity to a low setting in the event of false signals.** Always begin use at a reduced sensitivity level; use at full sensitivity after you have become familiar with the detector.
- 2) Do not use indoors.** This detector is for outdoor use only. Many household appliances emit electromagnetic energy, which can interfere with the detector. If conducting an indoor demonstration, turn the sensitivity down and keep the searchcoil away from appliances such as computers, televisions and microwave ovens. If your detector beeps erratically, turn off appliances and lights, especially those with dimmer switches.

Also keep the searchcoil away from objects containing metal, such as floors and walls.

- 3) Read this manual.** Most importantly, review the **Quick-Start Demo** (p.7-8) and **Basic Operation** (p. 9-12).
- 4) Use 9-volt ALKALINE batteries only.** Do not use Heavy Duty Batteries.

TABLE OF CONTENTS

Terminology	3
Assembly	4-5
Batteries	6
Quick-Start Demo	7-8
Basic Operation	9-12
All Metal	10
Discrimination	10
Notch	11
Zap	11-12
Pinpoint	12
Headphones	12
Audio Target Identification	13
Depth and Target Display	14-15
Sensitivity Adjustment	16
In The Field Techniques	17-21
Ground Balancing	20
Troubleshooting	22
Treasure Hunter's Code of Ethics	23
Warranty	23
Accessories	Back Page

TERMINOLOGY

The following terms are used throughout the manual, and are standard terminology among detectorists.

ELIMINATION - Reference to a metal being "eliminated" means that the detector will not emit a tone, nor light up an indicator, when a specified object passes through the coil's detection field.

DISCRIMINATION - When the detector emits different tones for different types of metals, and when the detector "eliminates" certain metals, we refer to this as the detector "discriminating" among different types of metals.

Discrimination is an important feature of professional metal detectors. Discrimination allows the user to ignore trash and otherwise undesirable objects.

NOTCH - Notching is the elimination of an item, or range of items, within the metallic spectrum. We "notch-out" an object, or objects, selectively. Objects to the left and right on the metallic spectrum can be retained using the notch technique.

RELIC - A relic is an object of interest by reason of its age or its association with the past. Many relics are made of iron, but can also be made of bronze or precious metals.

IRON - Iron is a common, low-grade metal that is an undesirable target in certain metal detecting applications. Examples of undesirable iron objects are old cans, pipes, bolts, and nails. Sometimes, the desired target is made of iron. Property markers, for instance, contain iron. Valuable relics can also be composed of iron; cannon balls, old armaments, and parts of old structures and vehicles can also be composed of iron.

FERROUS - Metals which are made of, or contain, iron.

PINPOINTING - Pinpointing is the process of finding the exact location of a buried object. Long-buried metals can appear exactly like the surrounding soil, and can therefore be very hard to isolate from the soil.

PULL-TABS - Discarded pull-tabs from beverage containers are the most bothersome trash items for treasure hunters. They come in many different shapes and sizes. Pull-tabs can be eliminated from detection, but some other valuable objects can have a magnetic signature similar to pull-tabs, and will also be eliminated when discriminating out pull-tabs.

GROUND BALANCE - Ground Balancing is the ability of the detector to ignore, or "see through," the earth's naturally occurring minerals, and only sound a tone when a metal object is detected. The Discovery 3300 incorporates proprietary Super-Scan™ circuitry to eliminate false signals from severe ground conditions

ASSEMBLY

Assembly is easy and requires no tools.

- 1 Position detector upright.
- 2 Rotate the LOCKING COLLAR fully in a counter clockwise direction.
- 3 Insert your finger inside the tube and make sure the INTERNAL CAM LOCK is flush with the inside of the tube.
- 4 Insert the LOWER STEM into the S-ROD.
- 5 Rotate the LOWER STEM until the SILVER BUTTON locates in the hole.
- 6 Twist the LOCKING COLLAR fully in the clockwise direction until it locks.
- 7 If your detector has 3 tubes and 2 locking collars, repeat this process on the Middle Stem.
- 8 Position the Lower Stem (the straight tube) with the Silver Button toward the back. Using the Bolt and Knurled Knob, attach the Searchcoil to the plastic extension protruding from the Lower Stem.
- 9 Press the button on the upper end of the Lower Stem, and slide the Lower Stem into the S-Rod.

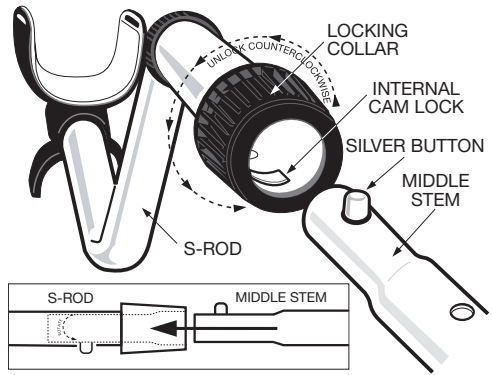

Adjust the Stem to a length that lets you maintain a comfortable upright posture, with your arm relaxed at your side, and the Searchcoil parallel to the ground in front of you.

- 10 Wind the Cable securely around the Stem.
- 11 Insert the Plug into the matching Connector on the right underside of the Detector Body. Be sure that the key-way and pins line up correctly.

Caution: Do not force the plug in. Excess force will cause damage. To disconnect the cable, pull on the plug.

Do not pull on the cable.

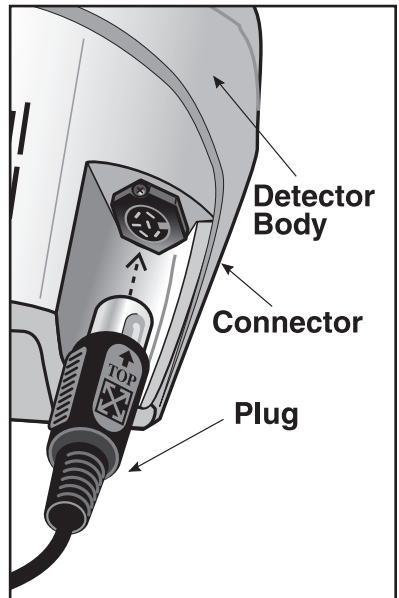

Adjusting the Armrest

Most people will find the standard position of the armrest very comfortable. Very large forearms and short forearms (particularly children's arms), can be accommodated by moving the armrest forward.

The armrest may be moved forward or backwards by removing the single screw and nut, and then repositioning the 2-piece armrest. Users with shorter arms may find the armrest more comfortable in the forward position. In order to move the armrest backwards, the plastic plug must be removed from the aluminum tube.

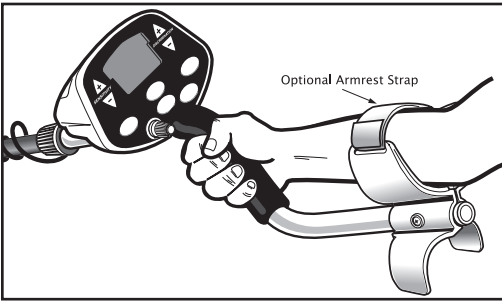

Armrest Strap

(optional accessory)

The strap is available for purchase as a separate accessory. Some users prefer to use the strap when swing the detector vigorously, in order to hold the detector secure against the arm.

The detector can also be used without the strap, with no compromise to detector balance and stability under most conditions.

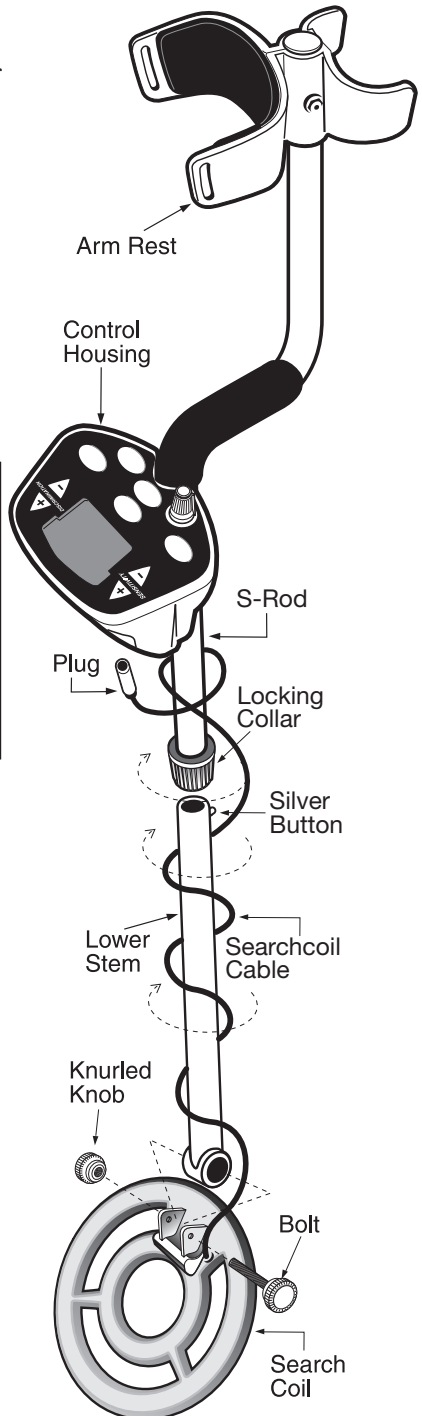

BATTERIES

Use **ALKALINE** batteries only.

To install the batteries:

- 1 Remove the battery cover by disengaging the clip at the back.
- 2 Align the polarity of the batteries correctly, with the positive "+" toward the coil plug connection, as indicated by the + and - indicators on the housing.
- 3 Insert (2) 9-Volt **ALKALINE** batteries, with the contacts pointed inward, and press down on the back of the batteries to snap them into place.

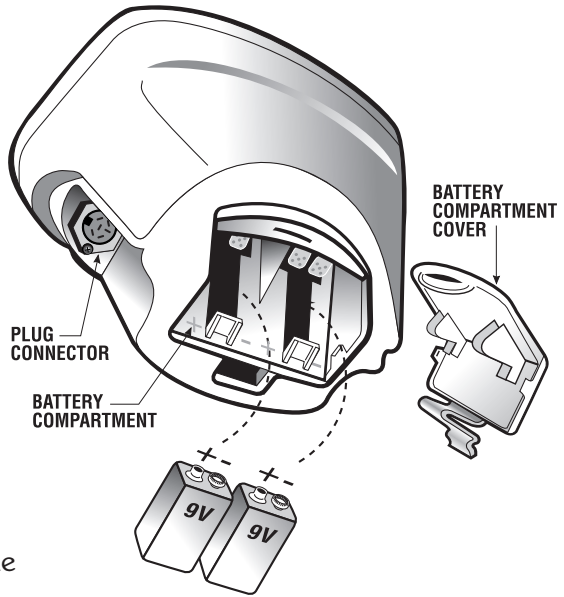

Some brands of batteries will require moderate force to clear the retaining tabs.

- 4 Replace the battery door.

Most metal detector problems are due to improperly installed batteries, or the use of non-alkaline or discharged batteries. **If the detector does not turn on, please check the batteries.**

DO NOT MIX OLD AND NEW BATTERIES

QUICK-START DEMONSTRATION

I. Supplies Needed

- A Nail
- A Pull-Tab from a beverage can
- A Nickel
- A Quarter
- A Zinc Penny (dated after 1982)

II. Position the Detector

- Place the detector on a table, with the searchcoil hanging over the edge. (or better, have a friend hold the detector, with the coil off the ground)
- Keep the searchcoil away from walls, floors, and metal objects.
- Remove watches, rings and other jewelry or metal objects from hands and wrists.
- Turn off appliances or lights that cause electromagnetic interference.
- Pivot the searchcoil back toward the detector body.

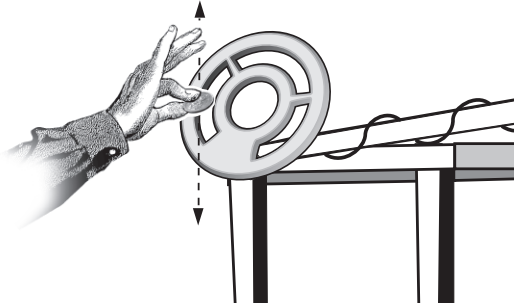

III. Power Up

Turn Ground Balance knob to pre-set position.

Press the POWER touch pad.

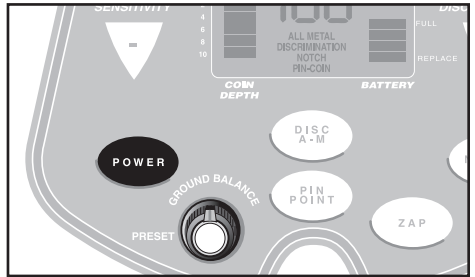

IV. Wave each Object over the Searchcoil

- Notice a different tone for each object.

Bass Tone: Nail
Low Tone: Pull-Tab
Medium Tone: Zinc Penny
High Tone: Quarter

- Motion is required. Objects must be in motion over the searchcoil to be detected.

V. Press the DISC A-M touch pad

The detector will beep twice and 3 "R"s will appear under the iron indicators.

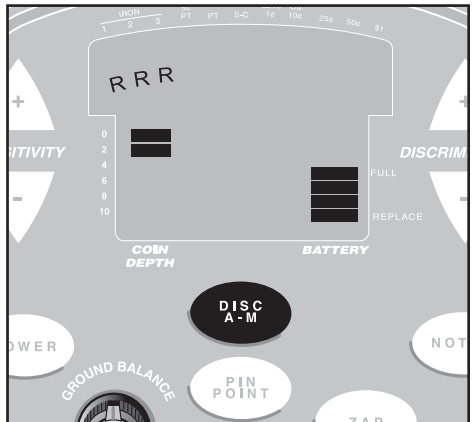

Quick-Start Demo continued on next page

QUICK-START DEMONSTRATION

VI. Wave the Nail over the Searchcoil

- The Nail will not be detected.
- The Nail has been "Discriminated Out."

VII. Press the "DISCRIMINATION-▲" touch pad twice.

Five "R"s are now displayed.

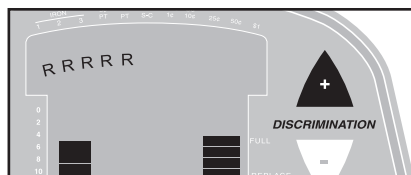

VIII. Wave all objects over the Searchcoil

The Nail and Pull-Tab will not be detected.

The other objects will be detected with their own distinctive tones.

IX. Press the NOTCH touch pad.

A flashing "R" will appear under the 5¢/PT segment.

X. Press the DISCRIMINATION ▲ touch pad three times.

The flashing "R" will move to the ZINC segment.

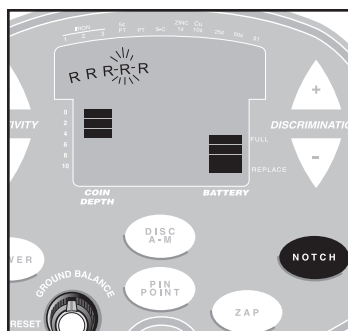

XI. Press the NOTCH touch pad again.

The "R" will appear under zinc.

XII. Wave the zinc penny over the searchcoil.

The penny is discriminated out.

XIII. Press the DISC A-M touch pad

The detector returns to ALL-METAL mode. No "R"s are displayed. All types of metals will be detected.

XIV. Wave the pull-tab over the coil.

XV. Press the ZAP touch pad.

An "R" will appear.

XVI. Wave the pull-tab over the searchcoil again.

The pull-tab (the most recently detected item) is eliminated from detection.



XVII. Press the PINPOINT touch pad.

Hold one of the metal objects motionless over the searchcoil.

- All Metal objects are now detected.
- Depth and Target indicator do not illuminate in this mode.
- One monotone sound indicates the presence of any type of metal.

BASIC OPERATION

POWERING UP

Press the **POWER** touch pad.

- The detector will beep 4 times
- All display segments will illuminate momentarily
- The **SENSITIVITY** (left) and **BATTERY** (right) indicators will stay illuminated

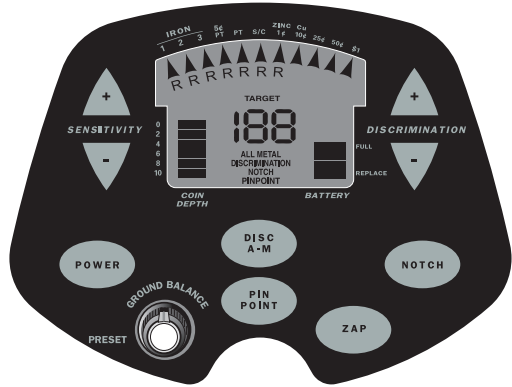

MOTION and NO-MOTION MODES

Depending on the operation mode selected, the Discovery 3300 detects metal both with the coil in motion, or with the coil motionless. In the **PINPOINT** mode of operation, metal is detected with the coil motionless over the ground. This no-motion operation helps to locate the exact location of buried objects, and is very useful in understanding the size and shape of buried metal objects. The **PINPOINT** mode offers deeper ground penetration, but cannot classify targets, nor indicate their depth.

The other operating modes require the coil to be in motion to detect a target. When in the **DISCRIMINATION**, **ALL-METAL** or **NOTCH** modes, the coil must be in continuous motion. It is often useful to search for targets in a motion mode, and when identified, pinpoint their location with the **PINPOINT** control.

SENSITIVITY

At its default sensitivity setting, the detector will detect a coin-sized object, such as a quarter, buried approximately seven inches deep. To change the sensitivity level, and thus the detection depth, press the **SENSITIVITY** ▲ or ▼ keys. The 6-segment scale at the left of the display, above "coin depth", indicates the sensitivity level when these touch pads are depressed.

CAUTION:

At higher sensitivity levels, the detector is susceptible to electromagnetic interference from electronic devices. Reduce sensitivity if demonstrating indoors or if using near power lines or electrical equipment.

Reduce sensitivity if detector emits false signals

ALL METAL MODE (Default Operation)

The detector defaults to **ALL METAL** mode after powering on. In this mode, all types of metals will be detected. An object's **PROBABLE** identification is indicated by the arrows at the top of the display. In addition, the **PROBABLE** depth of coin-sized objects is indicated by the rectangular segment indicators on the left side of the display. All detected objects will cause the depth indicator to illuminate. The depth indication is not accurate for larger objects; however, it will provide accurate relative depth indications. The greater the distance an object is from the searchcoil, the greater its depth value.

DISC/ A-M Touch Pad

Pressing this touch pad will cause the detector to toggle between two operating modes, **DISCRIMINATION** and **ALL-METAL**. If the detector is in the **ALL-METAL** mode (the default mode), pressing the touch pad will change the detector into **DISCRIMINATION** mode. If the detector is in the **DISCRIMINATION** mode, pressing the touch pad will change the detector into **ALL-METAL** mode.

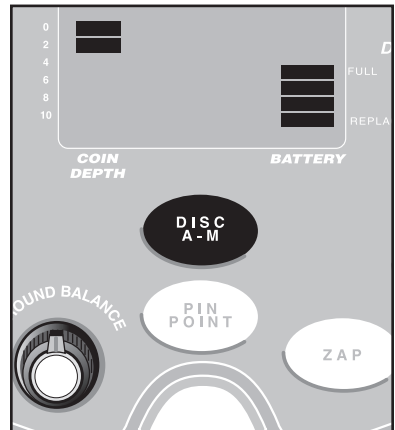

DISCRIMINATION MODE

Discrimination is used to eliminate unwanted objects from detection. To enter this mode, from **ALL-METAL** mode, press the **DISC/A-M** touch pad. After pressing **DISC/A-M**, the detector will:

- Beep twice
- Display 3 "R"s under the left-most segments, Iron 1, 2 & 3

Ferrous objects will not be detected in **DISCRIMINATION** mode.

Heavily oxidized ferrous objects will sometimes, however, be detected, usually with a high tone and an indication to the right of the target identification scale.

To increase the level of discrimination, press the **DISCRIMINATION ▲** touch pad. Each time the **▲** pad is depressed, an additional "R" will appear, thus eliminating from detection the objects which fall into the corresponding categories.

To decrease the level of discrimination, press the **DISCRIMINATION ▼** touch pad. Each time the **▼** pad is depressed, an illuminated "R" will

BASIC OPERATION

disappear, thus returning to detection the objects which fall into the corresponding categories.

Discrimination Mode is a fixed-start-point elimination system. Objects are cumulatively eliminated as the level of discrimination increases.

NOTCH MODE

To selectively eliminate a category from detection within the metallic spectrum, use the NOTCH Mode.

Technical Note:

The NOTCH touch pad causes the status of an "R" segment to toggle between ON and OFF.

To use the NOTCH Mode:

The NOTCH touch pad can be depressed at any time. But for first-time use, place the detector in DISCRIMINATION mode.

A first demonstration is best accomplished as follows:

- 1) Turn the power OFF.
- 2) Turn the power ON.
- 3) Press DISC/A-M
- 4) Press NOTCH.
A flashing "R" will appear under the IRON-1 segment.
- 5) Press the DISCRIMINATION ▲ touch pad several times.
Notice that the "R" moves upon each press of the DISCRIMINATION ▲ touch pad.
- 6) Press NOTCH again.
The flashing "R" will become permanently illuminated.

If an object has been "notched-out", you can return it to detection status. To "un-notch" a category:

- 1) Press NOTCH.
- 2) Move the flashing "R" over the permanently illuminated "R", using the DISCRIMINATION ▲ or ▼ touch pads.
- 3) Press NOTCH again.

After NOTCHING OUT a category the detector returns to the DISCRIMINATION mode.

ZAP

The ZAP control is a convenient way to eliminate a known undesirable metal object from detection. Zap only works in DISCRIMINATION MODE

To demonstrate the ZAP control:

- 1) Set the detector in DISCRIMINATION Mode
- 2) Pass the searchcoil over an undesirable object.
- 3) Notice the Target Indication
Note: You can only ZAP objects that register under the seven left-most segments (from Iron to Zinc).

BASIC OPERATION

- 4) Press ZAP. An "R" appears under the segment to be eliminated.
- 5) Pass the searchcoil over the same object again.

The undesirable object is eliminated from detection

The ZAP control is easy to use in the field. As you are detecting, and encounter an object which you wish to eliminate from detection, simply press the ZAP touch pad after detecting the object.

The ZAP control eliminates the most-recently detected object category from detection. The category eliminated is indicated with an "R".

PINPOINT MODE

Since long-buried objects can appear exactly like the surrounding soil, the process of finding the exact location of a small object, such as a coin, can be time-consuming and frustrating. Objects buried many inches deep present an especially daunting challenge. In addition, during the unearthing process, care must be taken not to damage valuable relics. The best solution to these problems is the no-motion PINPOINT mode.

At any time during operation, press the PINPOINT touch pad, and the detector enters the no-motion mode. In the PINPOINT mode, any object in the coil's detection field will induce a monotone hum. The location of a coin-sized object can be discerned with pinpoint accuracy as it will induce a tone only when it falls within the inner circle of the searchcoil. Pass the coil slowly over and around the target zone, and you will quickly see the target's exact location.

Be sure that the detector is properly GROUND BALANCED before using the PINPOINT MODE. See page 20 for manual ground balancing instructions. Also, consult page 22 for proper no-motion field techniques.

The Target Identification and Target Depth indicators are disabled in this mode. To discern the identification and depth of an object, you must use one of the motion modes of operation.

HEADPHONE JACK

Using headphones (not included) improves battery life, and prevents the sounds from annoying bystanders. It also allows you to hear subtle changes in the sound more clearly, particularly if searching in a noisy location. For safety reasons, do not use headphones near traffic or where other dangers are present. This device is to be used with interconnecting cables/headphone cables shorter than three meters.

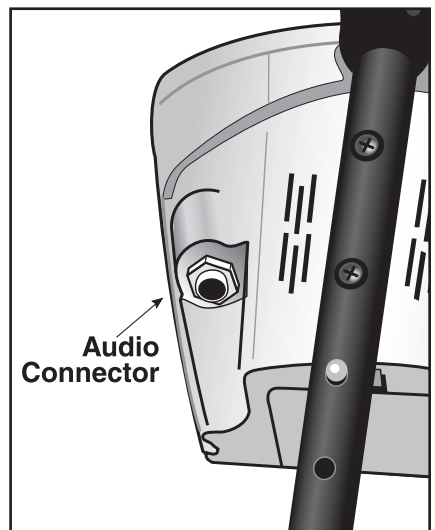

AUDIO TARGET IDENTIFICATION (motion modes only)

While the LCD (Liquid Crystal Display) is very accurate in identifying buried objects, the user in the field does not always maintain the display screen in his field of vision. Therefore, we have incorporated an audio feedback mechanism to alert the user to the nature of buried objects. This audio feedback system first alerts the user to the presence and classification of objects, whose nature and location can be confirmed using the LCD display.

The 4-tone audio target identification system functions only in the motion modes of operation. The detector must be in the DISCRIMINATION, NOTCH or ALL-METAL modes, as indicated on the display. In PINPOINT mode, the detector will emit only a monotone sound.

The detector can sound four different tones, depending on the object detected.

BASS TONE

Ferrous objects, such as iron and steel, will induce a bass tone. The smallest gold objects can also induce a bass tone.

LOW TONE





Pull-Tabs, nickels & smaller gold

MEDIUM TONE

Newer pennies (post-1982), larger gold objects, zinc, small brass objects, and most bottle screw caps will induce medium tones. Many recent vintage foreign currencies will induce medium tones.

HIGH TONE

Silver and copper coins, larger brass objects, older pennies (pre-1982), and highly oxidized metals will induce high tones. Quarters, dimes and other precious coins fall into this category.

BASS TONE	LOW TONE	MEDIUM TONE	HIGH TONE
			
Nails, Iron Objects, & Smallest Gold Objects	Pull Tabs, Nickels, & Smaller Gold	Zinc Pennies (Post 1982), Larger Gold Objects, Many screw caps	Copper, Silver & Brass Copper Pennies (Pre 1982)

Audio Target Identification (ATI) classifies metals into four categories.

DEPTH AND TARGET DISPLAY (motion modes only)

Please refer to the display on your detector and reference the TARGET I.D. categories below applicable to your model (not all detectors include all of these categories).

READING THE DISPLAY

The Liquid Crystal Display (LCD) shows the PROBABLE identification of the targeted metal, as well as the PROBABLE depth of the target.

The detector will register a consistent target identification, upon each sweep of the coil, when a buried target has been located and identified. If, upon repeated passes over the same spot, the target identification reads inconsistently, the target is probably a trash item, or oxidized metal. With practice, you will learn to unearth only the repeatable signals.

The segment identifications are highly accurate, when detecting the objects described on the label. However, if an object registers in a given category for an unknown buried object, you could be detecting a metallic object other than the object described on the label, but with the same metallic signature. Also, the greater the distance between the target and the coil, the less accurate the target identification.

GOLD TARGETS Gold objects will register toward the middle or left-of-center on the LCD scale.

Gold flakes may register under iron.

Small gold items may register under foil or 5¢.

Large gold items will register toward the center of the scale.

SILVER TARGETS: Silver objects will register to the right of the scale, under dime or higher.

IRON: All sizes of iron objects will register on the far-left side of the scale. This could indicate a worthless item

such as a nail, or a more valuable historic iron relic.

FOIL: Aluminum foil, such as a gum wrapper, will register as foil. A small broken piece of pull tab may also register here.

5¢: Most newer pull-tabs from beverage cans, the type intended to stay attached to the can, will register here. Many gold rings will also register here.

ALUM: Older pull tabs, which always detached completely from the can, register here. Many medium size gold ring also register here.

PT(pull-tabs): Pull-tabs from older beverage cans will register here. Few newer pull-tabs will also register here. Many gold rings will also register here.

S-CAP: Older screw caps from glass bottles will register here. Large gold rings, like a class ring, could also register here. Some non-U.S. coins of recent vintage will also register here.

Zinc: Medium conductivity objects and many non-U.S. coins of recent vintage are classified here.

The Target Identification Categories to the right of the display, such as copper coins, 10¢, DIME, 25¢, Quarter, 50¢, \$1 accurately identify these U.S. coins. When used in areas outside the U.S., these categories identify coins or metal objects of high relative conductivity (such as silver coins or relics), or large objects made of any type of metal.

Caution: The target indications are visual references. Many other types of metal can fall under any one of these categories. While the detector will eliminate or indicate the presence of most common trash items, it is impossible to accurately classify ALL buried objects.

DEPTH INDICATOR:

The Depth Indicator is accurate for coin-sized objects. It indicates the depth of the target, in inches. Large and irregularly-shaped objects will yield less reliable depth readings

When passing over an object, the depth indicator will light up and stay illuminated until another object is scanned. Repeated indication at the same depth level indicates an accurate target detector. If the depth indication varies with each sweep, try sweeping at different angles; there may be more than one target present. With practice, you will learn the difference between

accurate readings, multiple targets, and highly erratic readings which evidence trash or irregularly shaped objects.

THREE DIGIT TARGET INDICATOR

The three digit target indicator, in the middle of the LCD display, provides a specific target value to help identify buried targets more accurately. With practice in the field, you will learn to associate target values with the probable identification of buried objects. The target value can vary each time the coil passes over the target, depending upon the angle of the object and the distance from the coil. As a starting point, refer to the table below.

TARGET Readout

The table below list some common approximate target value equivalents. With experience in the field, you will recognize many types of metals by their numeric value.

VALUE RANGE	POSSIBLE OBJECTS
0-10	Iron
30-36	Nickel
43-48	Pull-Tab
53-60	Screw Cap
62-65	Zinc, Penny
83-88	Wheat Cent
86-89	Clad Dime
87-90	Mercury Dime
105-113	Clad Quarter
105-113	Liberty Dollar
120-126	Franklin Half Dollar
134-150	Silver Dollar
150-199	Large metal Object

SENSITIVITY ADJUSTMENT (motion modes only)

ELECTROMAGNETIC INTERFERENCE

The principle use for the Sensitivity Control is to eliminate Electromagnetic Interference (EMI).

A hobby metal detector is an extremely sensitive device; the searchcoil creates its own magnetic field and acts like an antenna. If your detector beeps erratically when the searchcoil is motionless, the unit is probably detecting another electromagnetic field.

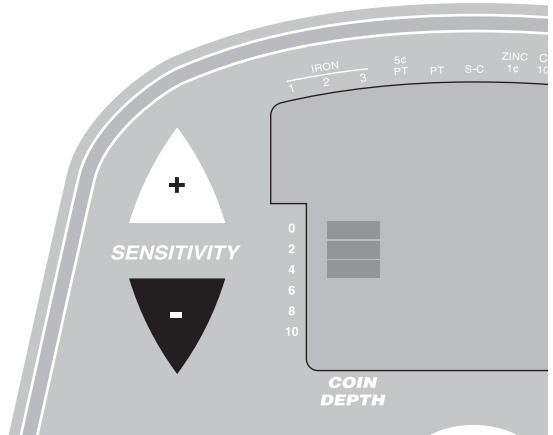

Common sources of EMI are electric power lines, both suspended and buried, motors, and household appliances like computers and microwave ovens. Some indoor electronic devices, such as dimmer switches used on household lighting, produce severe EMI and can cause the detector to beep erratically. Other metal detectors also produce their own electromagnetic fields; so if detecting with a friend, keep two metal detectors at least 20 feet apart.

If the detector beeps erratically, **REDUCE THE SENSITIVITY** by pressing the Sensitivity ▼ Pad on the left of the control panel.

SEVERE GROUND CONDITIONS

A secondary use for the Sensitivity Control is to reduce false detection signals caused by severe ground conditions. While your Discovery 3300 contains circuitry to eliminate the signals caused by most naturally occurring ground minerals, 100% of all ground conditions cannot be anticipated. Highly magnetic soils found in mountainous and gold-prospecting locations can cause the detector to emit tones when metal objects are not present. High saline content soils and sands can sometimes cause the detector to false.

If the detector emits false, non-repeatable, signals, **REDUCE THE SENSITIVITY**.

MULTIPLE TARGETS

If you suspect the presence of deeper targets beneath a shallower target, reduce the sensitivity to eliminate the detection of the deeper targets, in order to properly locate and identify the shallower target.

IN THE FIELD TECHNIQUES (motion modes only)

PINPOINTING IN MOTION MODES

Accurate pinpointing takes practice and is best accomplished by “X-ing” the target area.

1. Once a buried target is indicated by a good tone response, continue sweeping the coil over the target in a narrowing side-to-side pattern.
2. Take visual note of the place on the ground where the “beep” sounds.
3. Stop the coil directly over this spot on the ground.
4. Now move the coil straight forward and straight back towards you a couple of times.
5. Again make visual note of the spot on the ground at which the “beep” sounds.
6. If needed, “X” the target at different angles to “zero in” on the exact spot on the ground at which the “beep” sounds.

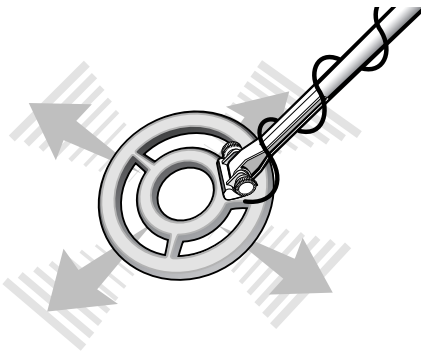

COIL MOVEMENT

When swinging the coil, be careful to keep it level with the ground about 1/2 inch from the surface. Never swing the coil like a pendulum.

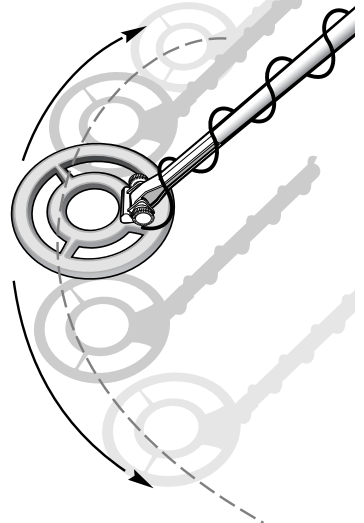
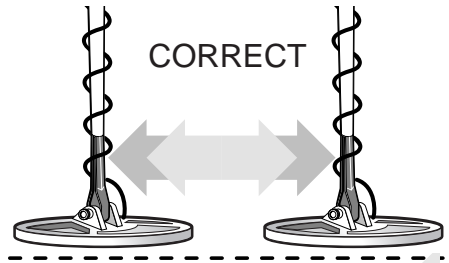
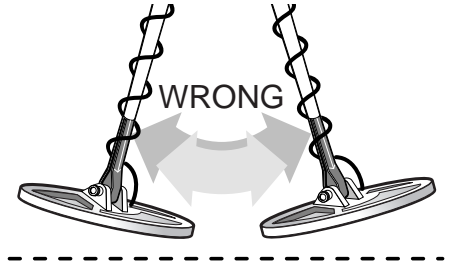

When pinpointing a target, try drawing an “X”, as illustrated, over where the tone is induced.

Swing the searchcoil slowly, overlapping each sweep as you move forward. It is important to sweep the coil at a consistent speed over the ground as you search. After identifying a target, your sweep technique can help in identifying both the location and the nature of the target. If you encounter a weak signal, try moving the coil in short, rapid sweeps over the target zone; such a short rapid sweep may provide a more consistent target identification.

Most worthwhile objects will respond with a repeatable tone. If the signal does not repeat after sweeping the coil directly over the suspected target a few times, it is more than likely trash metal.

Crossing the target zone with multiple intersecting sweeps at multiple angles is another way

to verify the repeatability of the signal, and the potential of the buried target. To use this method, walk around the target area in a circle, sweeping the coil across the target repeatedly, every 30 to 40 degrees of the circle, about ten different angles as you walk completely around the target. If a high-tone target completely disappears from detection at a given angle, chances are that you are detecting oxidized ferrous metals, rather than a silver or copper object. If the tone changes at different angles, you may have encountered multiple objects. If you are new to the hobby, you may want to dig all targets at first. With practice in the field, you will learn to better discern the nature of buried objects by the nature of the detector's response.

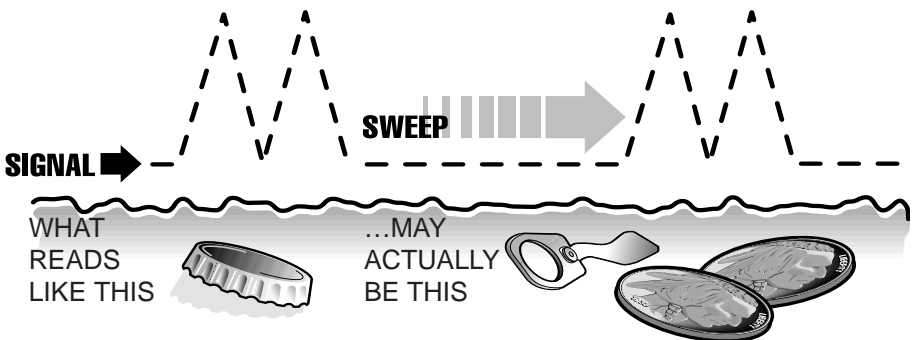

You may encounter some false signals as you proceed. False signals occur when the detector beeps, but no metal target is present. False signals can be induced by electromagnetic interference, oxidation, or highly mineralized ground soils. If the detector beeps once, but does not repeat the signal with several additional sweeps over the same spot, there is probably no target present.

When searching very trashing ground, it is best to scan small areas with slow, short sweeps. You will be surprised just how much trash metal and foil you will find in some areas. The trashiest areas have been frequented by the most people, and frequently hold the most promise for finding the most lost valuables. To make searching easier in very trashy areas, consider purchasing a 4-inch Searchcoil. The 4-inch

coil's narrower detection field can better distinguish between two objects in close proximity.

Also maintain the searchcoil positioned just above the surface of the ground, without making contact with the ground. Making contact with the ground can cause false signals.

False High Tones:

If detector emits false high tones in DISCRIMINATION mode, try rotating the GROUND BALANCE knob slightly counter clock wise.

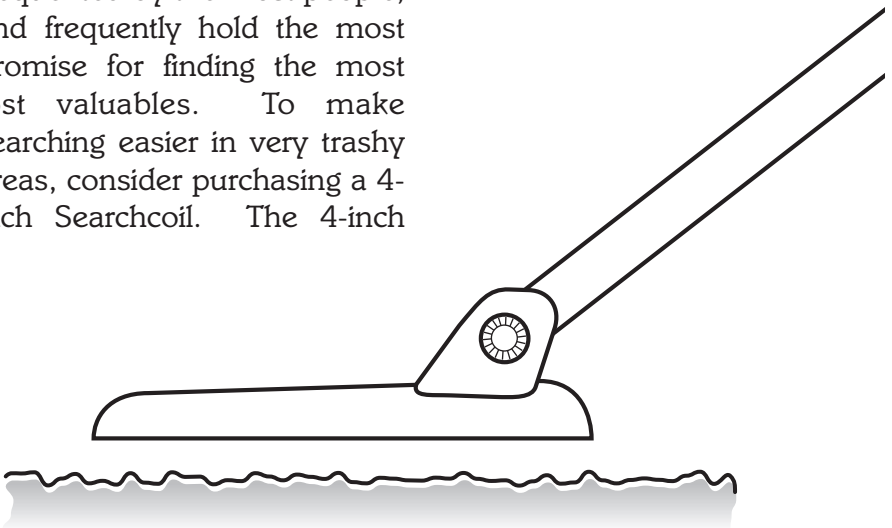

IN THE FIELD TECHNIQUES - Pinpoint Mode

GROUND BALANCING

Before using the PINPOINT mode, it is necessary to "Ground Balance" your detector, this ground balancing adjustment offsets the effects of minerals and slats in the ground.

To GROUND BALANCE your detector:

1. Using the ALL-METAL mode, find a patch of ground which is free of metal objects. You will use this section of ground to test the detector. The presence of any metal objects in this area will interfere with this procedure.
2. Begin with the ground balance KNOB in the PRESET position.

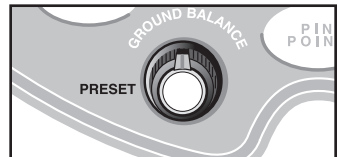

3. Lift the search coil waist high in the air.

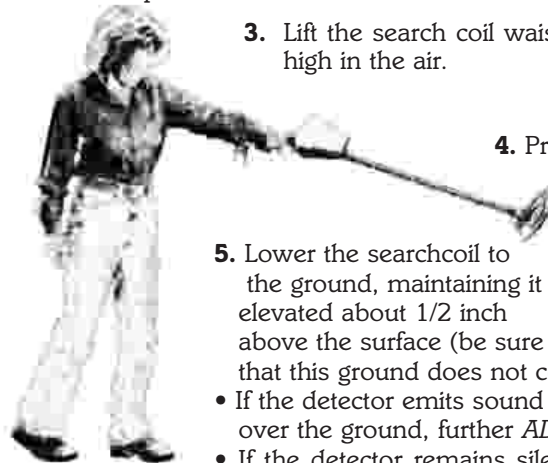

4. Press the PINPOINT touch pad.



5. Lower the searchcoil to the ground, maintaining it elevated about 1/2 inch above the surface (be sure that this ground does not contain metal).

- If the detector emits sound with the searchcoils 1/2 inch over the ground, further *ADJUSTMENT IS NECESSARY*.
 - If the detector remains silent with the searchcoil 1/2 inch over the ground, no further adjustment is necessary; the detector is "GROUND BALANCED"
6. If the detector emits sound with the coil over the ground in STEP 5, further adjustment of the ground balance KNOB is required as follows:
 - Lift the searchcoil waist high
 - Rotate the ground balance KNOB clockwise 1/16 of a turn
 - Press PINPOINT
 - Lower the searchcoil to the ground again

If the detector still emits a tone, repeat the procedure. You are searching for the ground balance knob position where the detector is *just silent*.

It is important to move the knob in small increments in order to find the first setting (moving clockwise) at which the detector remains silent. To insure yourself of the optimal adjustment, move the KNOB slightly counterclockwise from a silent-adjusted position to check for the *most counterclockwise silent position possible*.

If the KNOB is over-adjusted in the clockwise direction, the detector can lose sensitivity. An over-adjusted condition can also cause the detector to sound off when the coil is lifted away from the ground.

As your search takes you to different areas, verify the ground balance setting periodically using the above procedure. Within a geographical area, ground conditions can change. Varying elevation, proximity to water, and concentration of rock, sand or clay can all affect ground condition and sometimes require recalibrating with the ground balance knob.

- If the detector remains silent with the searchcoil 1/2 inch over the ground, no further adjustment is necessary; the detector is "GROUND BALANCED"

In the Pinpoint Mode, coil sweep technique is not important. Rather, user retuning is critical.

The detector does not automatically adjust to changing ground and environmental conditions; the operator is required to make the adjustment. If the detector sounds a constant tone over all areas of the ground, retune the detector by pressing the PINPOINT button.

RETUNING

Keep the coil still, just above the ground surface, and press the PINPOINT button. Make sure that the spot on the ground you chose for tuning did not contain metal; pass over the area with the coil again to insure that the detector does not emit a tone.

TEMPERATURE CHANGE

If the detector moves from one temperature environment to another, or if the temperature changes, you must retune the detector until the temperature stabilizes. If you move from a cooler to a warmer environment, the detector may emit a constant tone; if so, retune. If you move from a warmer to cooler environment, the detector may lose sensitivity; if so, retune.

PINPOINTING

Detection Field

The No-Motion's detection field depends on the size of the target.

Large Objects

After detecting a target, lift the coil off the ground to a distance where you hear the faintest tone. Move the coil over the ground at this height. If the tone does not fade, you have detected a large or irregularly shaped object. Outline the object with slow coil movements.

If you can outline an area larger than the size of the inside coil, you then have a large target, or several targets.

Large object can be detected when they enter the range of the outside coil.

Small Objects

After detecting a target, hold the searchcoil above the ground, at a distance where you hear the faintest tone. While maintaining the coil at this height above the ground, move the coil from side-to-side. Note the spot where the tone is loudest. Then move the coil toward the ground to zero-in on the target's location.

A coin-size object will be detected when the object enters the range of the inner coil.

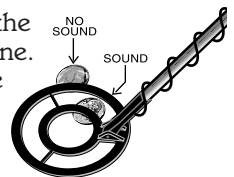

TROUBLESHOOTING

TROUBLESHOOTING GUIDE

SYMPTOM	CAUSE	SOLUTION
Detector chatters or beeps erratically	<ul style="list-style-type: none"> • Using detector indoors • Using detector near power lines • Using 2 detectors in close proximity • Highly oxidized buried object • Environmental electromagnetic interference 	<ul style="list-style-type: none"> • Use detector outdoors only • Move away from power lines • Keep 2 detectors at least 20' apart • Only dig up repeatable signals • Reduce sensitivity until erratic signals cease
Constant low tone or constant repeating tones	<ul style="list-style-type: none"> • Discharged batteries • Wrong type of batteries 	<ul style="list-style-type: none"> • Replace batteries • Use only 9V alkaline batteries
LCD does not lock on to one target ID or detector emits multiple tones	<ul style="list-style-type: none"> • Multiple targets present • Highly oxidized target • Sensitivity set too high 	<ul style="list-style-type: none"> • Move coil slowly at different angles • Reduce sensitivity
No power, no sounds	<ul style="list-style-type: none"> • Dead batteries • Cord not connected securely 	<ul style="list-style-type: none"> • Replace batteries • Check connections
Detector sounds continuous tone in Pinpoint Mode when coil is lifted away from ground.	<ul style="list-style-type: none"> • Ground Balance over-adjusted 	<ul style="list-style-type: none"> • Move Ground Balance knob counter-clockwise
Detector sounds continuous tone with coil over ground	<ul style="list-style-type: none"> • Detector needs to be retuned 	<ul style="list-style-type: none"> • Press Pinpoint • Re-ground balance

TREASURE HUNTER'S CODE OF ETHICS:

- Always check Federal, State, County and local laws before searching.
- Respect private property and do not enter private property without the owner's permission.
- Take care to refill all holes and leave no damage.
- Remove and dispose of any and all trash and litter found.
- Appreciate and protect our inheritance of natural resources, wildlife and private property.
- Act as an ambassador for the hobby, use thoughtfulness, consideration and courtesy at all times.
- Never destroy historical or archaeological treasures.
- All treasure hunters may be judged by the example you set; always conduct yourself with courtesy and consideration of others

5-YEAR LIMITED WARRANTY

The **Discovery 3300** metal detector is warranted against defects in materials and workmanship under normal use for five years from the date of purchase to the original owner.

Damage due to neglect, accidental damage, or misuse of this product is not covered under this warranty. Decisions regarding abuse or misuse of the detector are made solely at the discretion of the manufacturer.

Proof of Purchase is required to make a claim under this warranty.

Liability under this Warranty is limited to replacing or repairing, at our option, the metal detector returned, shipping cost prepaid to First Texas Products. Shipping cost to First Texas Products is the responsibility of the consumer.

To return your detector for service, please first contact First Texas for a Return Authorization (RA) Number. Reference the RA number on your package and return the detector within 15 days of calling to:

First Texas Products L.L.C.

1465-H Henry Brennan Dr.

El Paso, TX 79936

Phone: 915-633-8354

NOTE TO CUSTOMERS OUTSIDE THE U.S.A.

This warranty may vary in other countries, check with your distributor for details. Warranty does not cover shipping costs.

According to FCC part 15.21 Changes or Modifications made to this device not expressly approved by the party responsible for compliance could void the users authority to operate this equipment.

This device complies with FCC Part 15 Subpart B Section 15.109 Class B.

Copyright© 2012 by First Texas Products, L.L.C.

All rights reserved, including the right to reproduce this book, or parts thereof, in any form, except for the inclusion of brief quotations in a review.

Published by First Texas Products, L.L.C.

Bounty Hunter® is a registered trademark of First Texas Products, L.L.C.

www.detecting.com



1465-H Henry Brennan • El Paso, TX 79936 • (915) 633-8354

ACCESSORIES

Carry Bag

Rugged double-stitched construction - *CBAG-W*

Pouch & Digger Combo

Pouch with 2 large pockets & 9" heavy duty digging tool. *TP-KIT-W*

Bounty Hunter Stereo Headphones

Use with Bounty Hunter metal detectors. Lightweight and adjustable with true stereo sound, adjustable volume, 1/8" jack with 1/4" adaptor, 4' cable. *HEAD-W*

Pinpointer

Pinpoints the exact location of buried metal objects. Audio signal indicator and vibrator. Runs on 1 – 9-Volt Battery. *PIN POINTER-W*

Sand Scoop

Large scoop with filtering holes. Made of strong plastic. *SAND SCOOPBH*

Replacement/Accessory Searchcoils

10" Magnum Searchcoil – *10COIL*

8" Replacement Standard Searchcoil – *8COIL-N*

4" Gold Nugget Searchcoil – *4COIL*

Searchcoil Covers

Protect your coil from abrasion and damage.

10" Searchcoil Cover – *10COVER*

8" Searchcoil Cover – *8COVER-N*

4" Searchcoil Cover – *4COVER*

9" Heavy-Duty Digging Tool

Metal blade with comfortable plastic handle and depth gauge *TROWEL-2*

Digging Tool

Light and practical wide blade digging tool. *TROWEL-W*

Bounty Hunter T-Shirt

100% cotton with Bounty Hunter® Logo. Sizes – LG, XL & XXL

Bounty Hunter Baseball Cap

One size fits all, with Bounty Hunter® logo.

Gold Prospecting Kits

Items Included:

	Gold Kit PART NUMBER: GOLDKIT1	Deluxe Kit PART NUMBER: GOLDKIT2	Hardrock Kit PART NUMBER: GOLDKIT3
10 1/2" Gold Pan	x	x	x
14" Gold Pan	x	x	x
Classifier		x	x
2 – Shatterproof Vials	x	x	x
Snuffer Bottle	x	x	x
Black Sand Magnet		x	x
Treasure Scoop		x	x
Tweezers			x
Magnifier			x
Crevice Tool			x
Rock Pick			x
Instruction Booklet	x	x	x
Backpack		x	x

FOR COMPLETE DETAILS VISIT WWW.DETECTING.COM • 1-800-413-4131

