



MASTERVOLT

USERS MANUAL / GEBRUIKERSHANDLEIDING
BETRIEBSANLEITUNG / MANUEL UTILISATEUR
MANUAL DE UTILIZACION / INSTRUZIONI PER L'USO

Solar ChargeMaster

SCM-N 20/ SCM-N 40

INTELLIGENT CHARGE CONTROLLER



MASTERVOLT
Snijdersbergweg 93,
1105 AN Amsterdam
The Netherlands
Tel.: +31-20-3422100
Fax.: +31-20-6971006
www.Mastervolt.com

ENGLISH:	PAGE 1
NEDERLANDS:	PAGINA 17
DEUTSCH:	SEITE 33
FRANÇAIS:	PAGINA 49
CASTÉLLANO:	PÁGINA 65
ITALIANO:	PÁGINA 81

v 1.2 November 07

CONTENTS

v 1.2 November 07

CONTENTS	2
1 GENERAL INFORMATION	2
2 SAFETY GUIDELINES AND MEASURES	3
3 BEFORE YOU START	4
4 INSTALLATION	6
5 OPERATION	8
6 CONFIGURATION	10
7 TROUBLE SHOOTING	14
8 TECHNICAL SPECIFICATIONS	15
9 CE DECLARATION OF CONFORMITY	16

1 GENERAL INFORMATION

1.1 Use of this manual

This manual serves as a guideline for the safe and effective operation, maintenance and possible correction of minor malfunctions of the Solar ChargeMaster.

It is therefore obligatory that every person who works on or with the Solar ChargeMaster is completely familiar with the contents of this manual, and that he/she carefully follows the instructions contained herein.

Installation of, and work on the Solar ChargeMaster, may be carried out only by qualified personnel, consistent with the local standards and taking into consideration chapter 2 of this manual.

Keep this manual at a secure place!

The English version counts 16 pages.

1.2 Guarantee specifications

Mastervolt guarantees that this unit has been built according to the legally applicable standards and specifications. The guarantee is limited to the costs of repair and/or replacement of the product. Costs for installation labor or shipping of the defective parts are not covered by this guarantee.

1.3 Validity of this manual

All of the specifications, provisions and instructions contained in this manual apply solely to standard versions of the Solar ChargeMaster delivered by Mastervolt.

Part number	Description
131802000	Solar ChargeMaster SCM-N 20
131804000	Solar ChargeMaster SCM-N 40

For other models see other manuals available on our website: www.mastervolt.com.

1.4 Quality

During their production and prior to their delivery, all of our units are tested and inspected.

1.5 Liability

Mastervolt can accept no liability for:

- consequential damage due to use of the Solar ChargeMaster;
- possible errors in the manuals and the results thereof.

1.6 Identification label

The identification label is located at the bottom side of the Solar ChargeMaster. (see figure 1). Important technical information required for service, maintenance & secondary delivery of parts can be derived from the identification label.



Figure 1: Identification label



CAUTION!

Never remove the identification label.

1.7 Changes to the Solar ChargeMaster

Changes to the Solar ChargeMaster may be carried out only after obtaining the written permission of Mastervolt.

2 SAFETY GUIDELINES AND MEASURES

2.1 Warnings and symbols

Safety instructions and warnings are marked in this manual by the following pictograms:



A procedure, circumstance, etc. which deserves extra attention.



CAUTION!

Special data, restrictions and rules with regard to preventing damage.



WARNING

A WARNING refers to possible injury to the user or significant material damage to the charger if the user does not (carefully) follow the procedures.

2.2 Use for intended purpose

1 The Solar ChargeMaster is constructed as per the applicable safety-technical guidelines.

2 Use the Solar ChargeMaster only:

- for the charging of Gel, AGM and flooded lead acid batteries and the switching of DC loads;
- with a fuse, protecting the wiring between the Solar ChargeMaster and the battery;
- in undamaged condition;
- in a closed, well-ventilated room, protected against rain, moist, dust and condensation;
- observing the instructions in this users manual.



WARNING

Never use the Solar ChargeMaster in situations where there is danger of gas or dust explosion or in vicinity of potentially flammable products!

3 Use of the Solar ChargeMaster other than mentioned in point 2 is not considered to be consistent with the intended purpose. Mastervolt is not liable for any damage resulting from the above.

2.3 Organizational measures

The user must always:

- have access to the user's manual;
- be familiar with the contents of this manual.

This particularly applies to chapter 2, Safety Guidelines and Measures.

2.4 Maintenance & repair

In case of maintenance and repair activities, disconnect batteries and PV modules to prevent unintentional damage to the installation.

Except for the connection compartment, the cabinet of the Solar ChargeMaster must not be opened.

There are no serviceable parts inside the cabinet.

If maintenance and repairs are required, please consult your local Mastervolt Service Center.

2.5 General safety and installation precautions

- In case of fire, you must use the fire extinguisher which is appropriate for electrical equipment.
- Short circuiting or reversing polarity may lead to serious damage to batteries and the wiring.
- Damage to the Solar ChargeMaster caused by reversed polarity or short circuiting will void warranty.
- Protect the DC wiring with a fuse, according to the guidelines in this manual.
- Connection and protection must be done in accordance with local standards.
- Do not work on the Solar ChargeMaster or system if it is still connected to a power source. Only allow changes in your electrical system to be carried out by qualified electricians.
- Check the wiring and connections at least once a year. Defects such as loose connections, burnt cables etc. must be corrected immediately.

2.6 Warning regarding the use of batteries.

Excessive battery discharge and/or high charging voltages can cause serious damage to batteries. Do not exceed the recommended limits of discharge level of your batteries. Avoid short circuiting batteries, as this may result in explosion and fire hazard. Installation of the batteries and adjustments of the Solar ChargeMaster should only be undertaken by authorised personnel!

3 BEFORE YOU START

3.1 Utilizing environments

The Solar ChargeMaster facilitates a stand alone energy system. Typical applications of this charge regulator are:

- weekend homes;
- mobile applications;
- street lighting applications.

These categories implicate different ways to use the Solar ChargeMaster.

3.1.1 Weekend homes

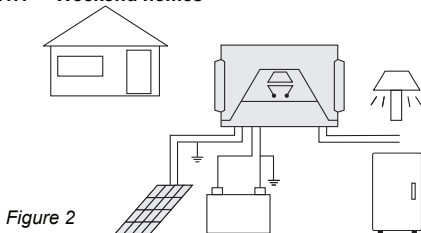

Figure 2

In weekend homes (no grid provided) the batteries are charged by the Solar ChargeMaster. A generator is not allowed in most recreational areas. The night light function is convenient to manage the loads automatically, thus preventing the batteries from being discharged too deeply overnight. See section 6.1.

3.1.2 Mobile applications

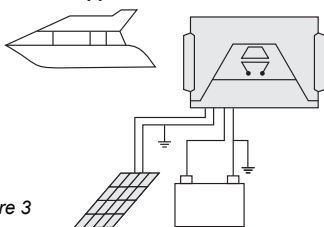

Figure 3

In mobile applications the batteries are charged by the alternator and/ or an optional external power source. The Solar ChargeMaster is used generally for maintaining the batteries charged when no other power source is available.

3.1.3 Street lighting

In remote street lighting applications the Solar ChargeMaster is the only charger in the energy system. For example street lights and road signs are often solar powered.

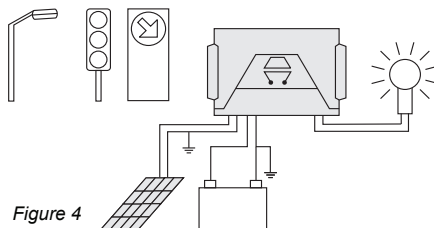

Figure 4

Overnight the battery is discharged during a preset time, using the nightlight function Dusk to Dawn. At day the battery is recharged.

3.2 PV system calculation

For an optimal autonomous solar system, it is important to use batteries with the right capacity and the right amount of solar cells for your load. Four design phases could be distinguished.

3.2.1 Calculating the daily energy consumption

In the table below the energy use of a weekend home is shown (Hours of use times watts).

Device	Daily usage Hrs (h)	Device Watts (W)	Daily Watt hours Used (Wh)
Lights (5x)	6.0	50	300
Television	4.0	100	400
Washing Machine	1.0	800	800
Total daily Watt hours used (Wh)			1500



Usually the energy consumption during both the summer and winter period is determined.

3.2.2 Determining the period of autonomy

The period of autonomy is the time a solar system must be able to “survive” without solar irradiation. This period depends on the environmental circumstances.

3.2.3 Calculating the battery capacity

The battery must be large enough to provide you with energy during the period of autonomy. Take into account a 50% maximum discharge of the battery to prevent it from ageing early.

3.2.4 Calculating the PV capacity

The PV panels have to deliver the daily energy consumption (see section 3.2.1). Take into account the irradiation and energy consumption during both summer and winter periods for calculation of your PV system. Ask your PV panel dealer for more information. See section 3.3 for voltages.

3.3 Number of PV cells

The Solar ChargeMaster is appropriate for nominal 12V and 24V solar systems. The table shows the number of cells required for the nominal voltages. For measuring the voltages, the typical values for the open clamp voltage (V oc) and the maximum power point voltage (V mpp) could be useful.

Nominal PV voltage	Nominal battery voltage	Number of cells	Typical values	
			V oc	V mpp
12V	12V	36	22V	18V
24V	24V	72	44V	36V



With a 12V system the Solar ChargeMaster 40 can supply a maximum power of 480W. To connect higher power devices, you will need more than one Solar ChargeMaster or change the system voltage to 24 V.

3.4 Care for your batteries

For proper care of your batteries it is important to keep them as fully charged as possible and to fully charge them frequently (every 2 to 4 weeks). This will extend the battery life span. An alternative energy source may be needed for this purpose during extended periods of low irradiation.

Another important issue is reducing the amount of discharging cycles. For more info regarding your battery refer to the recommendations of the battery manufacturer.

3.5 Overview of the Solar ChargeMaster

Figure 5 shows all serviceable parts of the Solar ChargeMaster.

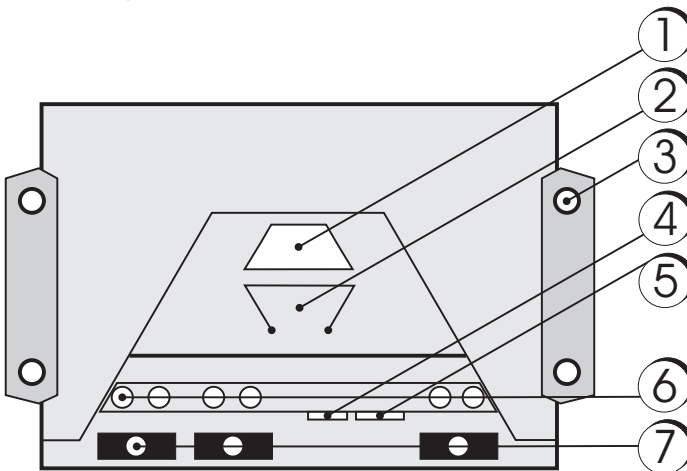

Figure 5 Overview Solar ChargeMaster

- 1. LCD screen
- 2. Button
- 3. Fastening hole
- 4. PC Link connector (4 pins)
- 5. Battery temperature sensor (5 pins)
- 6. Screw terminals
- 7. Strain relieves

4 INSTALLATION



WARNING
During installation and commissioning of the Solar ChargeMaster, the Safety Guidelines and Measures are applicable at all times. See chapter 2 of this manual.



CAREFUL!
Wrong connections may cause damage to the Solar ChargeMaster and other equipment as well, which is not covered by warranty!

4.1 Grounding the Solar System

Be aware that the Solar ChargeMaster has negative grounding. See also figure 7. The negative terminals of the Solar ChargeMaster controller are connected internally and therefore have the same electrical potential. If any grounding is required, always connect this to the negative wires.

4.2 Things you need for installation

4.2.1 Tools:

A cross-head screw driver is all you need for the strain relieves, the screw terminals and the fastening screws for the housing. See also figure 5.



WARNING!
Use isolated tools!

4.2.2 Materials:

Part	Part nr.	Incl.
Solar Chagemaster SCM-N 20	131802000	
Solar Chagemaster SCM-N 40	131804000	
Temperature sensor	41500900	yes
PC Link USB (option)	21730400	no
4 screws 4,5 mm for wall mounting		no
DC wiring		no

For advanced use you need the Solar ChargeMaster data control software (downloadable from www.Mastervolt.com)

Mind the recommended wire size, see this table.

Model	Length < 1m	Length 1-3
SCM20-N	4 mm ²	6 mm ²
SCM40-N	10 mm ²	16 mm ²

Place positive and negative wire close to each other to minimize electromagnetic effects.



Mind that the screws have to carry also the force applied by the wiring. Mind the minimum required distance of 10 cm/ 4" to floor and ceiling, this is necessary for ventilation reasons.

Installation step by step

1. Open the terminal lid. See figure 6.
2. Remove the screws from the strain relief and take off the strain relief bridges. See figure 5 too.
3. Mount the controller to the wall. Use appropriate screws for the wall material. Use screws with 4 to 5 mm shaft and max. 10 mm head diameter, no counter sunk. See figure 5 for locating the mounting holes.



Figure 6

4. Connect the wires leading to the battery with correct polarity. See figure 7. To avoid any voltage on the wires, first connect the controller, then the battery.

Wrong polarity will cause a permanent warning sound.

The controller has a built-in voltage drop compensation which automatically compensates battery wire voltage drops of up to 250 mV.



WARNINGS!

- If the battery is connected with reverse polarity, the load terminals will also have the wrong polarity. Never connect loads during this condition!
 - A fuse must be integrated in the positive lead to the battery to protect any short circuit at the battery wiring. Mind the recommendations of your battery manufacturer.
 - The fuse must take the charge controller maximum current: Solar ChargeMaster20: 30A, Solar ChargeMaster40: 50A.
 - Solar panels provide voltage as soon as exposed to sun light. Mind the solar panel manufacturer's recommendations in any case.
5. To avoid voltage at the load terminal, push the button (see figure 5) shortly to shut off the load output.
 6. Connect the wires leading to the loads with correct polarity. See figure 7.
 7. Fasten the strain relieves.

8. If applied, connect the battery temperature sensor (5 pins) and / or the PC Link (4 pins).
 9. Close the terminal lid.
- Stick the battery sensor to the top of your battery.

Now you have successfully connected your Solar ChargeMaster controller.

4.3 Connections

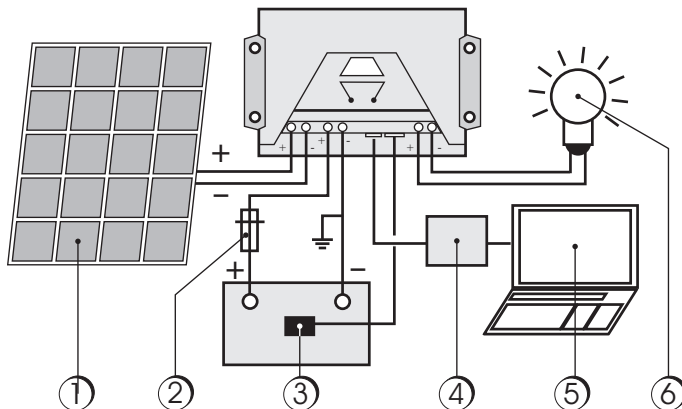

Connections including the battery temperature sensor and the MasterAdjust PC connected. The positive battery leg has been fused.

1. Solar panel
2. Battery fuse
3. Temperature sensor
4. PC Link USB interface
5. PC for MasterAdjust
6. Load

Figure 7: Connections

4.4 Connectors

4.4.1 Serial port

The controller comes with a serial port for connection to a PC with the PC Link (optional). See the PC Link manual for details. In Section 6.1.8 the serial interface behaviour can be modified.

4.4.2 BatteryTemperature Sensor connector

With the temperature sensor (included), Solar ChargeMaster can measure the battery temperature and adjust the charging voltage accordingly to extend the battery life span.

4.5 Safety features

The Solar ChargeMaster is protected against:	Solar terminal	Battery terminal	Load terminal
Battery connected with correct polarity to:	Unrestricted	Normal operation	Unrestricted
Battery connected with wrong polarity to:	Unrestricted	Unrestricted	Unrestricted
Reverse polarity at:	24V system: no 12V system: yes	Yes, if only the battery is connected. Acoustic warning.	Load output is protected, but loads may be damaged.
Short circuit at:	Unrestricted	Unrestricted Caution: fuse the battery	Unrestricted
Overcurrent at:	Controller limits current	Not applicable	Controller switches off load terminal.
Thermal overload at:	Controller is protected electronically	Not applicable	Controller switches off load terminal.
No connection at:	Unrestricted	Unrestricted	Unrestricted
Reverse current at:	Unrestricted	Not applicable	Not applicable
Overvoltage at:	Varistor 56 V 2,3J	Maximum 40 V	Controller switches off load terminal.
Undervoltage at:	Normal operation	Controller switches off load terminal.	Controller switches off load terminal.

5 OPERATION

5.1 Recommendations for use

- During installation you switched off the load. Switching on is obtained manually with a short press of the button, see figure 9.
- The regulator warms up during normal operation. If there is insufficient ventilation (e.g. in an installation cabinet), the controller limits the solar charge current to prevent overheating.
- The regulator does not need any maintenance or service. Remove dust with a dry tissue.
- A battery can only be fully charged if not too much energy is drawn during charging. Keep that in mind, especially if you install additional loads.

5.2 Button switch

The button switch (number 1 on figure 5) has three push modes (see section 6.1):

Short push	Shorter than 2 seconds
Long push	2 to 8 seconds
Lock mode	8 seconds or longer

5.3 Display Functions and Acoustic Signals

5.3.1 LCD screens

In normal operation mode the controller displays the state of charge (available energy) of the battery, see figure 8 and 9. Any change of the state of charge (SOC) to a lower status is signalled acoustically, see figure 8.

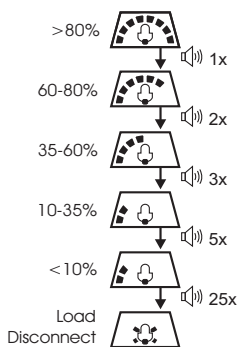

Figure 8: System conditions

The percentage corresponds to the energy available until Low Voltage Disconnect in relation to a fully charged battery.

As long as the solar array supplies enough voltage to charge the battery, this is indicated by up-moving bars alternately to the state of charge display.

In normal operation the loads can be switched on and off by pushing the button (figure 5). See figure 9 for the displays.

Special conditions are shown in the LCD screen if the Low Voltage Disconnect function shuts off the load output or in case of various other error conditions. See chapter 7 for details.

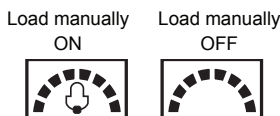

Figure 9: Load control

5.3.2 Acoustic Signals

The controller has an acoustic signal which indicates the change of the state of charge. This function can be deactivated in section 6.1.7.

5.4 Description of Functions

5.4.1 Low Voltage Disconnect Function (LVD)

The controller has 5 different modes to protect the battery from being discharged deeply:

Mode 1 (option)

- Disconnect at 11.4 V (at nominal load current) up to 11.9 V (at no load current). Normal operation mode for good battery protection.

Mode 2 (option)

- Disconnect at 11.0 V (at nominal load current) up to 11.75 V (at no load current). Mode with lower disconnection point. Battery is cycled deeper, this can shorten battery lifetime.

Mode 3 (option)

- Disconnect at 11.0 V to 12.2 V depending on load current and previous charging cycles. This adaptive mode leads to longer lifetime of the battery because it allows recovery of the battery by full recharge. Maximum battery life.

Mode 4 (option)

- Disconnect at 11.5 V fixed setting. Appropriate if bypass loads draw current directly from battery.

Mode 5 (option)

- Disconnect at 11.0 V fixed setting. Appropriate if bypass loads draw current directly from battery. Mode with lower disconnection point. Battery is cycled deeper, this can shorten battery lifetime.

The controller is preset to Mode 1 from the factory.

See section 6.1.2 to change the setting.

In case of doubts which mode to choose, consult your battery dealer because this has to be evaluated depending on the battery used.

5.4.2 Nightlight Function

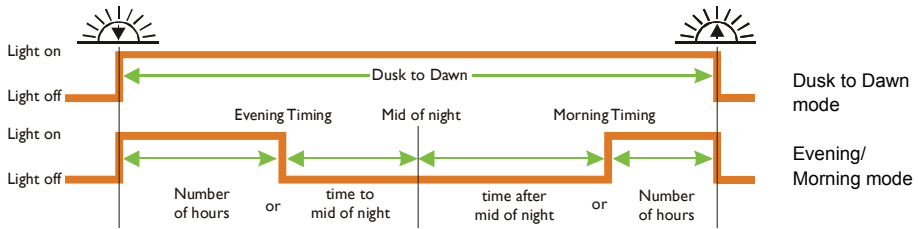

Figure 10: Nightlight function modes

The Solar ChargeMaster controller comes with a sophisticated night light function. It controls the load output at night and is widely programmable. Default this function is disabled, two alternatives are available:

Dusk to Dawn and Evening/ Morning.

- The Dusk to Dawn mode (continuous at night) can be selected in Section 6.1.3.
- If Evening/ Morning is selected, Section 6.1.4 allows choosing the Evening timing behaviour and Section 6.1.5 allows choosing the Morning timing behaviour. See also figure 10.



Mind that the load output is switched off as soon as the battery has reached the Low Voltage Disconnect threshold.

“Mid of night” is detected automatically as the middle between dusk and dawn, no real time setting is required. It may take some days until the controller has “learnt” midnight. This method can cause some inaccuracy but avoids any clock readjustment.

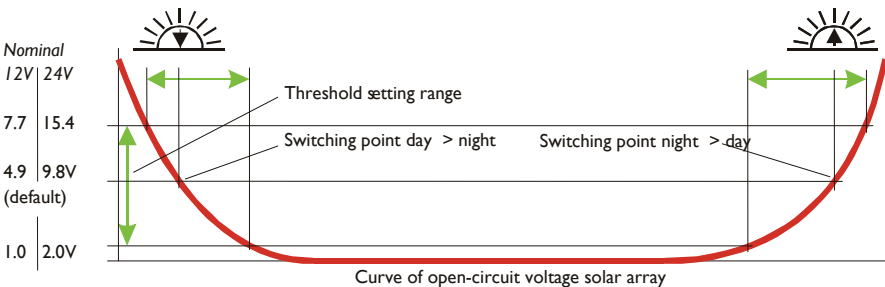

Figure 11: Switching points

The controller’s “Mid of night” can be different from the real time midnight depending on your location.

The controller recognizes day and night based on the solar array open circuit voltage, see figure 11. In Section 6.1.6 this day/night threshold can be modified according to the requirements of the local conditions and the solar array used.

To find the right value, we recommend measuring the solar array open circuit voltage at the time when the controller switches on/off at twilight. See section 6.1.6 to set this value (the closest available).

5.4.3 Locking

By pushing the programming button for 8 s in normal operation mode the programming lock is activated to prevent any accidental settings change. Another 8 sec push releases the lock.

6 CONFIGURATION

6.1 Programming your Solar ChargeMaster

With a long push (2s-8s) on the button the programming mode is opened. The programming menu structure is described in the table below. A black wide arrow means a long push (2s-8s), a grey arrow means a short push (<1 sec). The dotted lines under "Setting" mean you see the actual selection there. During selection the symbols under "Settings menu" are flashing.

When you exit the configuration menu, the controller displays the state of charge (available energy) of the battery and the status of the load.

Mind that once you have entered the configuration menu you can exit it at the last item only.

We therefore recommend that you first note down your required settings and then do the configuration in one go.

All configuration settings are stored in a non-volatile memory and remain stored even if the controller was disconnected from the battery.

6.1.1 Battery type

Description	Displays	Settings
In this menu, you can select the proper battery type - liquid electrolyte or GEL (VRLA) /AGM according to your PV system to get better charge of your battery. The default battery type is liquid electrolyte.		Battery type liquid electrolyte Battery type Gel

6.1.2 Low voltage disconnect

Description	Displays	Settings
In this menu, you can set 5 different Low Voltage Disconnect (LVD) modes to protect the battery from being discharged deeply. See section 5.4.1 for details.		LVD, current compensated, 11.4-11.9V/ 22.8-23.8V
The default low voltage disconnect (LVD) setting is Mode 1 - Disconnect at 11.4 V (at nominal load current) up to 11.9 V (at no load current).		LVD, current compensated, 11.0-11.75V/ 22.0-23.50V
		LVD, current compensated/ adaptive, 11.0-12.2V/ 22.0-24.4V
		LVD 11.5V/ 23V
		LVD 11.0V/ 22V

6.1.3 Night light function (type)

Description	Displays	Settings
In this menu, you can set the type of night light function or switch off the night light function of your Solar ChargeMaster controller. See section 5.4.2 for details.		Night light function OFF
The default setting of night light function type is OFF.		Night light function Dusk to Dawn
		Night light function Evening/Morning

6.1.4 Nightlight function (evening settings)

Description	Displays	Settings
<p>With the nightlight function type set to the EVENING/MORNING mode, you can set the EVENING timing in this menu. See section 5.4.2 for details.</p> <p>The default nightlight function EVENING is OFF.</p>		Nightlight function
		EVENING OFF
		EVENING. Dusk to:
		1HR after dusk
		2HRS after dusk
		3HRS after dusk
		4HRS after dusk
		5HRS after dusk
		4HRS before mid of night
		3HRS before mid of night
		2HRS before mid of night
		1HRS before mid of night
		Mid of night

6.1.5 Nightlight function (morning settings)

Description	Displays	Settings
<p>With the nightlight function type set to the EVENING/MORNING mode, you can set the MORNING timing in this menu. See section 5.4.2 for details.</p> <p>The default nightlight function MORNING is OFF.</p>		MORNING OFF
		Morning From: to dawn
		1HR before dawn
		2HRS before dawn
		3HRS before dawn
		4HRS before dawn
		5HRS before dawn
		2HRS after mid of night
		3HRS after mid of night
		4HRS after mid of night
		5HRS after mid of night
		6HRS after mid of night

6.1.6 Day/Night threshold

Description	Displays	Settings
<p>In this menu, you can set the open circuit voltage of PV panel that the Solar ChargeMaster controller should know it's day or night.</p> <p>See section 5.4.2 for details.</p> <p>The default day/night threshold is 4.9V for 12V PV system (9.8V for 24V PV system).</p>	<p>Function Setting Settings menu</p>	<p>Day/Night threshold 1.0/ 2.0 V Solar Voltage</p> <hr/> <p>Day/Night threshold 1.6/ 3.1 V Solar Voltage</p> <hr/> <p>Day/Night threshold 2.1/ 4.2 V Solar Voltage</p> <hr/> <p>Day/Night threshold 2.7/ 5.4 V Solar Voltage</p> <hr/> <p>Day/Night threshold 3.2/ 6.5 V Solar Voltage</p> <hr/> <p>Day/Night threshold 3.8/ 7.6 V Solar Voltage</p> <hr/> <p>Day/Night threshold 4.4/ 8.7 V Solar Voltage</p> <hr/> <p>Day/Night threshold 4.9/ 9.8 V Solar Voltage</p> <hr/> <p>Day/Night threshold 5.5/ 11.0 V Solar Voltage</p> <hr/> <p>Day/Night threshold 6.0/ 12.1 V Solar Voltage</p> <hr/> <p>Day/Night threshold 6.6/ 13.2 V Solar Voltage</p> <hr/> <p>Day/Night threshold 7.2/ 14.3 V Solar Voltage</p> <hr/> <p>Day/Night threshold 7.7/ 15.4 V Solar Voltage</p>

6.1.7 Buzzer on/off

Description	Displays	Settings
<p>You can turn ON/turn OFF the buzzer in this menu.</p> <p>Default: ON</p>	<p>Function Setting Settings menu</p>	<p>Buzzer ON</p> <hr/> <p>Buzzer OFF</p>

6.1.8 Setting of Serial interface

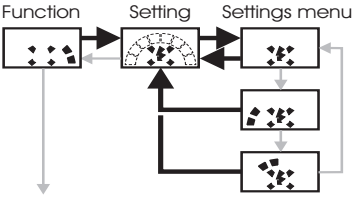

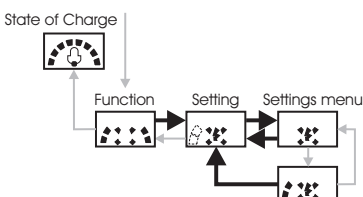

Description	Displays	Settings
<p>For proper functioning of the PC link, selection of the third mode is recommended. See also section 4.4.1. Default: Read in of current data.</p>		<p>Read in of current data.</p> <p>Read back of data logger</p> <p>PC link bidirectional communication</p>

6.1.9 Individual / factory settings

Description	Displays	Settings
<p>You can save your current menu setting or reset to default factory setting in this menu.</p>		<p>Keep individual settings</p> <p>Reset to factory settings</p>

7 TROUBLE SHOOTING

Error Description

Error condition	Display	Reason	Remedy
Loads are not supplied (flashing symbols).		Battery is low	Load will reconnect as soon as battery is recharged.
		Overcurrent / Short circuit of loads	Switch off all loads. Remove short circuit. Controller will switch on load automatically after max 1 minute.
		Controller is thermally overloaded and has disconnected the loads.	Check proper ventilation of controller. After cooling down the loads are reconnected automatically.
		Battery voltage too high (>15.5 / 31.0 V)	Check if other sources overcharge the battery. If not, controller is damaged.
Battery is flat after short time		Battery has low capacity	Change battery
Battery is not being charged during daytime	No up-moving bars	Solar array faulty or wrong polarity	Check Solar array and wiring
Battery wrong polarity	Permanent sound	Battery is connected with reverse polarity	Change polarity
Controller limits solar current (flashing symbols).		Controller is thermally overloaded	Mount controller at a location with better ventilation
		Solar array exceeds nominal current of controller.	Check solar array current.

8 TECHNICAL SPECIFICATIONS

8.1 Technical Data

Variable	SCM-N-20	SCM-N-40
Nominal voltage	12 / 24 V, automatic recognition	12 / 24 V, automatic recognition
Number of PV cells serial	36 or 72 cells, refer to section 3.2	36 or 72 cells, refer to section 3.2
Max solar voltage input @ Tmin	50 V	50 V
Absorption voltage	14.4 / 28.8 V (25°C)	14.4 / 28.8 V (25°C)
Equalization voltage	14.8 / 29.6 V (25°C), 2 h	14.8 / 29.6 V (25°C), 2 h
Float voltage	13.7 / 27.4 V (25°C)	13.7 / 27.4 V (25°C)
Load disconnect voltage	11.0-12.2 / 22.0 -24.4 V depending on setting	11.0-12.2 / 22.0 -24.4 V depending on setting
Load reconnect voltage	12.8 / 25.6 V	12.8 / 25.6 V
Temperature compensation	-24 mV/°C@12V, -48 mV/°C@24V	-24 mV/°C@12V, -48 mV/°C@24V
Max. solar panel current @25°C (without load current @ 50°C)	20 A	40 A
Max. load current @25°C (without solar current @ 50°C)	20 A	40 A
Dimensions	140 x 105 x 41 mm (w x h x d)	140 x 105 x 41 mm (w x h x d)
Weight	222 gr	232 gr
Max. wire size	16 mm ² (AWG #6)	16 mm ² (AWG #6)
No load power consumption	4 mA	4 mA
Ambient temperature	-25 to +50 °C	-25 to +50 °C
Case protection	IP 20	IP 20

8.2 Dimensions

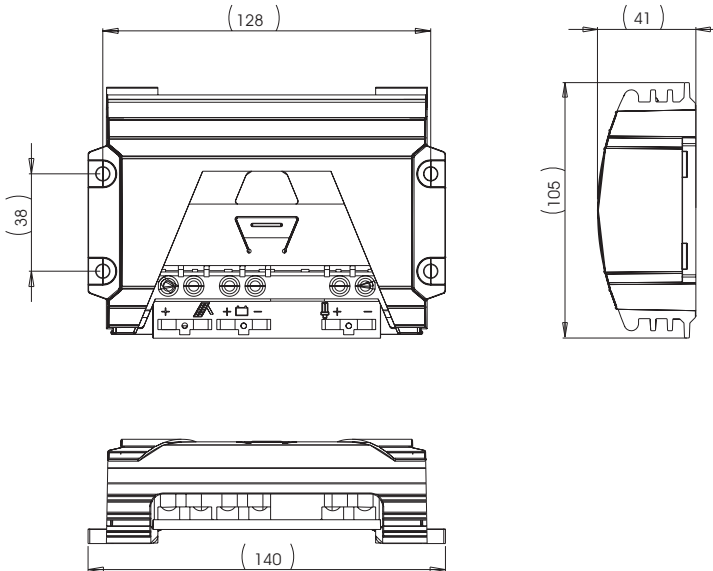

Figure 12 Dimensions in mm

9 CE DECLARATION OF CONFORMITY

Manufacturer: Mastervolt

Address: Snijdersbergweg 93
1105 AN Amsterdam
The Netherlands

Herewith declares that:

Product: Solar ChargeMaster SCM-N 20
Solar ChargeMaster SCM-N 40

Is in conformity with the directives and standards:

2006/95/EC	Electrical Apparatus Low Voltage Directive
89/336/EEC	Electromagnetic compatibility directive
93/68/EEC	CE marking
EN 60730-1	Electrical safety standard
EN 60730-2-11	Electrical safety standard

Amsterdam,

P.F. Kenninck,
General Manager MASTERVOLT**MASTERVOLT**Snijdersbergweg 93, 1105 AN Amsterdam, The Netherlands
Tel : + 31-20-3422100
Fax : + 31-20-6971006
Email : info@mastervolt.com