



RECREATIONAL VEHICLE (RV)

Carbon Monoxide Alarm

USER'S MANUAL

65 Series Surface Mount Models:

65-541, 65-541-R, 65-541-MS, 65-541-R-MS

65 Series Flush / Recess Mount Models:

65-542, 65-542-R, 65-542-MS, 65-542-R-MS

ALL RIGHTS RESERVED 65RV120810-6

ATTENTION: This user's manual contains important Carbon Monoxide (CO) alarm installation, operation, troubleshooting and warranty information. Read, follow, and keep this manual for future reference.

NOTE: If you install or purchase this alarm for another person, give this manual to that person.

IMPORTANT: This unit must be replaced within five years of its installation date. This unit has an End of Life (EOL) signal that will sound after 5 years of use. Record the installation date in the section, Owner's Replacement Record, in this manual for future use. The replacement date indicates the date beyond which the device may no longer detect carbon monoxide. The device should be replaced.

The electronic CO sensor in your SAFE-T-ALERT™ CO alarm is very sensitive to CO gas. It will not react to most other gases.

WHY EVERY RV NEEDS A 65 SERIES CO ALARM

Everyone is at risk for carbon monoxide poisoning! Particularly sensitive are children, pregnant women, the elderly and people with lung or heart disease or anemia! Carbon monoxide (CO) is an odorless, colorless gas that prevents the blood from carrying oxygen to vital organs. CO is 200 times more likely to replace oxygen in the blood. The Consumer Product Safety Commission (CPSC) recommends using at least one CO alarm located outside of sleeping areas. For the extra security, locate additional CO alarms in each sleeping area.

ABOUT THIS ALARM

Because CO is a colorless, odorless, tasteless and highly poisonous gas; it can endanger lives even at low levels of concentration. The CO Alarm will alert you to potentially dangerous situations. **The following symptoms may be related to CO POISONING. Discuss these symptoms with ALL household members and RV guests:**

- **Mild Exposure:** Headaches, running nose, sore or watery eyes, often described as "flu-like" symptoms.
- **Medium Exposure:** Dizziness, drowsiness, vomiting.
- **Extreme Exposure:** Unconsciousness, brain damage and death.

NOTE: Reported cases of CO gas poisoning indicate that while victims are aware they are not well, they are disoriented. They are unable to save themselves by exiting the RV or calling for assistance. **Small children and pets may be affected first.**

Your SAFE-T-ALERT™ Series alarm helps protect your family members and guests from CO produced while using your RV. CO gas is produced when any type of fuel is incompletely burned. Potential sources of CO in and around your RV can include gas or diesel engine exhaust, portable space heaters, gas stoves and ovens, furnaces, defective engine exhaust systems, charcoal, portable grills, other nearby RVs, portable generators, generator exhaust, and other propane-powered appliances. All are sources of CO.

The following are also sources of CO that may affect your RV:

- Extended operation of unvented fuel burning appliances can build up high CO levels.
- An idling vehicle in an open or closed garage.
- Temperature inversions can trap exhaust near the ground.
- CO build up can be caused by reverse/negative venting of fuel burning appliances including: 1) Clogged, loose or faulty stacks or chimneys of (clothes dryers, furnaces and water heaters, etc.), 2) wind direction and/or velocity, 3) simultaneous operation of multiple fuel burning appliances, and/or exhaust fans.



LIMITATIONS OF CO ALARMS

THIS ALARM WILL NOT WORK WITHOUT POWER. Some reasons for no alarm power; are a blown or missing fuse, broken wire, a faulty wire connection or circuit breaker, a discharged battery, cut lead wires, or improper supply (+) or ground (-) connections.

THIS ALARM WILL ONLY INDICATE THE PRESENCE OF GAS AT THE SENSOR. CO may be present in other areas. MTI recommends installing CO alarms in all sleeping areas. **Do not block or cover** the alarm with any object that can prevent carbon monoxide from reaching the sensor.

THIS ALARM IS INTENDED FOR USE IN RV's. It is intended for use inside the RV. It is not designed to measure compliance with commercial and industrial standards.

THIS ALARM MAY NOT BE HEARD. The alarm's loudness is designed to meet or exceed regulatory standards; however, the alarm may not be heard if alarms are located in remote locations or behind closed doors. Persons who are hard-of-hearing, have consumed alcoholic beverages, taken prescription, non-prescription or illegal drugs, may not hear the alarm.

THIS ALARM IS DESIGNED TO DETECT CARBON MONOXIDE. THE ALARM IS NOT DESIGNED TO DETECT SMOKE, OR FIRE.

THIS ALARM MAY NOT ALARM AT LOW CO LEVELS It is not designed to measure compliance with the Occupational Safety Health Administration (OSHA) commercial or industrial standards. Individuals with medical problems may consider using warning devices, which provide audible and visual signals for CO concentrations under 30 ppm.

HOW TO PROTECT YOUR FAMILY

CAUTION- The SAFE-T-ALERT™ 65 Series combination CO Alarm is designed to protect individuals from the acute effects of carbon monoxide exposure. It will not fully safeguard individuals with specific medical conditions. If in doubt, consult a medical practitioner.

To protect yourself, family and guests, you should:

- **INSTALL THE ALARM PROPERLY.** Carefully read and follow ALL the instructions in this manual. Test your unit every week. Alarms that do not work will not alert you to hazardous levels of CO and need to be replaced.. See the section, **Test Procedure**, in this manual for further information.
- **MAKE REGULAR VISUAL INSPECTIONS.** Check all fuel burning equipment including gas water-heaters, kitchen gas stoves, space heaters, gas dryers and all pilot lights. Check the color of the pilot flame. The color should be blue.
- **MAKE REGULAR VISUAL INSPECTIONS OF THE ENGINE AND GENERATOR EXHAUST SYSTEMS.** Cracked exhaust systems can allow CO to enter the living area.
- **PROFESSIONALLY MAINTAIN YOUR ENGINE AND GENERATOR.** Although gas engines and generators produce CO, a poorly tuned engine and generator will produce greater amounts CO.

WHERE TO INSTALL

- MTI recommends installing a gas alarm in each sleeping area.
- **The NFPA and Consumer Product Safety Commission recommends installing a CO alarm outside the sleeping area. The 65 Series CO alarm complies with that recommendation.**
- **INSTALL ALARM** at least 4 inches off the floor.

WHERE NOT TO INSTALL 65 SERIES ALARMS

- **DO NOT INSTALL** behind furniture, drapes, in closets or areas that will block air flow to the alarm.
- **DO NOT INSTALL** within 12 inches (30cm) of opening windows, exterior doors, heating or return vents, or other drafty areas..
- **DO NOT INSTALL** on an outside wall.
- **DO NOT INSTALL** on a wall switch controlled by a power line, ground fault circuit or to a circuit breaker.

NOTE: Older RVs may have little or no insulation and therefore are draftier. Carefully consider mounting locations. The following diagrams provide additional alarm installation information:

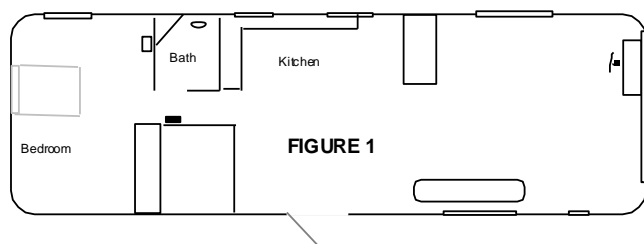

■ CO DETECTOR LOCATION FOR MINIMUM SECURITY

□ CO DETECTOR LOCATION FOR ADDITIONAL SECURITY

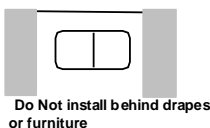
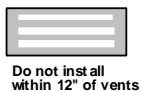
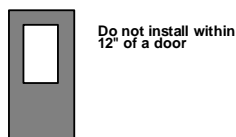
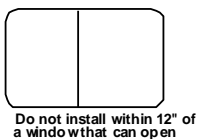

FIGURE 2

INSTALLATION INSTRUCTIONS

Models



WARNING

FAILURE TO FOLLOW THESE INSTRUCTIONS MAY RESULT IN A MALFUNCTION OR FAILURE OF THE ALARM AND MAY VOID THE WARRANTY.

SHOCK HAZARD: Turn off power before installing.

Power Supply 12 VDC.

Recommended Wire Size 14 GA. TO 18 GA.

Connect the alarm to a properly fused circuit, maximum over protection device rating 6 amps.

All connections must be in accordance with the National Electrical Code in the Unites Stated and the Canadian Electric Code in Canada .

Connect to wiring or circuit that CANNOT be turned off by a switch or ground fault protector. Only use UL or recognized permanent wire connectors. It is acceptable to connect the 65 Series CO alarm to the main disconnect. The alarm will be off along with all other 12 volt equipment when the main disconnect is turned to the off position. The RV must not be occupied when the main disconnect is in the off position.

INSTALLATION INSTRUCTIONS

Follow these instructions carefully. Failure to follow these instructions can damage the unit and void the warranty.

Important: The 65 Series Flush / Recess mount case requires 1 1/2" (38mm) clearance behind the wall.

MODEL 65-541 / 65-542

1. **Basic Model 65-541/65-542** - Select a wall location at least 4" off the floor. Cut a 5 5/8" (143mm) W x 3 1/8" (79mm) H hole. For the 60-541 Drill a 1/4" (6mm) hole for the wires.
2. Connect Supply (+) to the Red wire lead. Install a 1 amp fuse in the positive (+) circuit. Connect the Black wire to the 12 volt Ground (-).
3. Reconnect the power supply. Warm up 10 minutes then test the alarm.

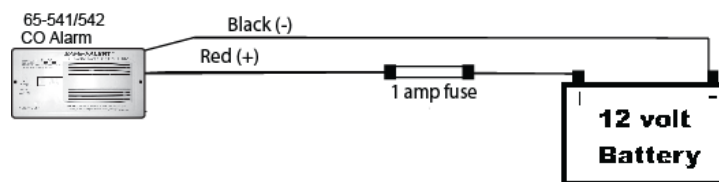

MODEL 65-541-R / 65-542-R (Relay Control)

1. **Model 65-541-R/65-542-R - With Normally Closed relay.** This unit supplies a relay with contacts rated 12 VDC, 3 amp (max). The relay is energized whenever the alarm is operational. It may be used to shut down a generator or to open an (optional) gas solenoid valve. The relay may also be used to interface to alarm systems, using either the normally closed or normally open contact, depending on the requirements of the alarm system. In the event of an alarm the relay will shut off. It will

automatically re-energize after the unsafe levels of CO clears. Select a wall location at least 4" off the floor. 60-542-R Cut a 5 5/8" (143mm) W x 3 1/8" (79mm) H hole. 60-541-R drill 1/4" (6mm) hole for the wires.

2. **Do not connect to a previously installed solenoid. SEE: SPECIAL WIRING NOTICE.**
3. Connect Supply (+) to the Red wire lead. Install a 5 amp fuse in the positive (+) circuit. Connect the Black wire to the 12 volt Ground (-).
4. Reconnect the power supply. Warm up 10 minutes then test the alarm.

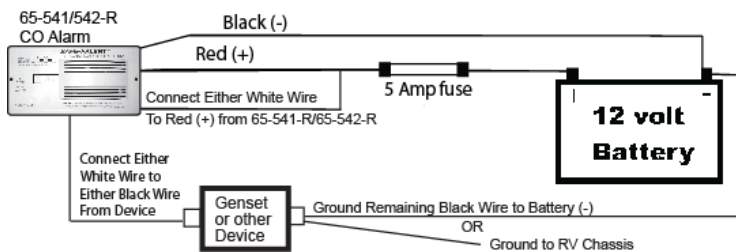

MODEL 65-541-MS / 65-542-MS

1. **Model 65-541/65-542-MS Multi-station interconnect, (Maximum 10 units and 2000 feet of wire).** Allows multiple 65-541/542MS alarms to be connected together. When one of the alarms detects unsafe levels of CO or gas it will activate. It will also activate the audible alarm of all the interconnected units. Only the alarm that detected CO or gas will have its Red LED light lit up so that you can determine the cause of the alarm. Select a wall location no between 4" and 20" off the floor. 60-542-MS Cut a 5 5/8" (143mm) W x 3 1/8" (79mm) H hole. 60-541-MS drill 1/4" (6mm) hole for the wires.
2. Connect the Red wire to the 12 volt supply (+). Install a 1 amp fuse in the positive circuit (+). **Note you must use a separate 1 amp fuse for each alarm.** Connect the Black wire to the 12 volt Ground (-).
3. Interconnect Wiring – Connect Blue wires from each alarm and Yellow wires for each alarm. Continue connecting in series (Daisy Chain).
4. Reconnect the power supply. Warm up 10 minutes then test the alarm.

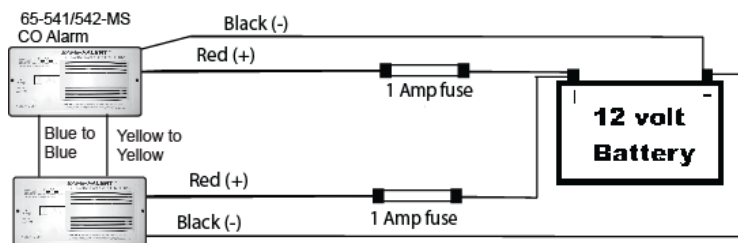

MODEL 65-541-R-MS / 65-542-R-MS

1. **Model 65-541-R/65-542-R-MS - With Normally Closed relay.** This unit supplies a relay with contacts rated 12 VDC, 3 amp (max). The relay is energized whenever the alarm is operational. It may be used to shut down a generator or to open an (optional) gas solenoid valve. The relay may also be used to interface to alarm systems, using either the normally closed or normally open contact, depending on the requirements of the alarm system. In the event of an alarm the relay will shut off. It will automatically re-energize after the unsafe levels of CO clears. Select a wall location at least 4" off the floor. 65-541-R-MS Cut a 5 5/8" (143mm) W x 3 1/8" (79mm) H hole. 65-542-R-MS drill 1/4" (6mm) hole for the wires.
2. **Do not connect to an existing installed solenoid. SEE: SPECIAL WIRING NOTICE.**

3. Connect Supply (+) to the Red wire lead. Install a 5 amp fuse in the positive (+) circuit. Connect the Black wire to the 12 volt Ground (-).
4. Interconnect Wiring - Connect Blue wires from each alarm and Yellow wires from each alarm. Continue connecting in series (Daisy Chain).
5. Reconnect the power supply. Warm up 10 minutes then test the alarm.

Model 65-541-R-MS / 65-542-R-MS Wiring -

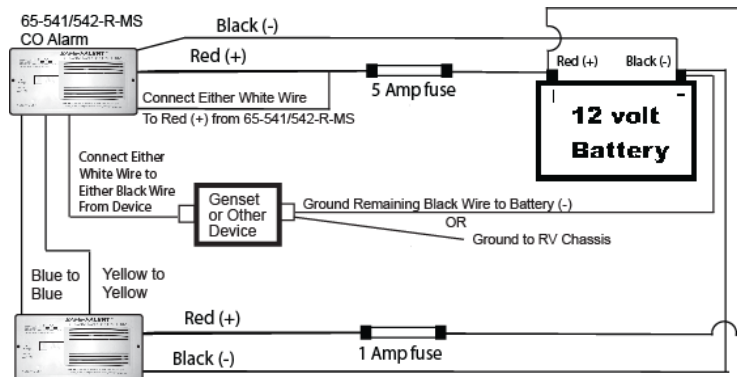

Only use UL or recognized permanent wire connectors to replace any unit installed with spade connectors or wire nuts.

TEST PROCEDURE



WARNING

TO REDUCE THE RISK OF CARBON MONOXIDE POISONING, TEST THIS ALARM'S OPERATION AFTER THE RV HAS BEEN IN STORAGE, BEFORE EACH TRIP AND AT LEAST ONCE PER WEEK DURING USE BY PRESSING THE TEST/RESET BUTTON.



WARNING

WARNING: THE TEST BUTTON ONLY TESTS THE ALARM CIRCUIT NOT THE SENSORS. TO TEST THE CO SENSOR USE A CAN OF SAFE-T-ALERT CO TEST GAS TO TEST THE 400 PPM CALABRATION POINT. DO NOT TRY TO GENERATE CO TO TEST THE ALARM. The TEST/RESET button tests all ELECTRICAL functions of the alarm. It does not check the sensor operation.

The alarm may be tested at any time. The TEST/Mute switch is located on the front of the alarm. Press and hold the test button for 1 second **IMPORTANT - If this alarm does not test properly return it immediately for repair or replacement. If the alarm is over five years old replace it.**

SPECIAL WIRING NOTICE.

⚠ DANGER - FIRE RISK - DO NOT CONNECT A SAFE-T-ALERT alarm to non Safe-T-Alert supplied solenoid. You must use a new solenoid with the correct electrical rating.

OPERATION

When the unit is first powered up, the CO sensor requires a ten (10) minute initial warm-up period to clean the sensor element and achieve stabilization. The GREEN LED indicator will flash on and off during the 10 minute warm-up period. This unit cannot go into a alarm during the warm-up period. See Test Procedure in this manual. After the warm-up period, the GREEN power ON indicator should glow continuously. If the ON indicator light does not light, see the section, **Trouble-Shooting Guide**, in this manual for further information. **Do not attempt to fix it yourself.**

Brownout Protection - The unit can tolerate short power interruptions and brownouts where the circuit voltage drops as low as 1 VDC. If the brownout lasts too long, the unit will reset and operate as described above.

LOW POWER OPERATION

This alarm will operate normally down to 7 VDC. Do not operate this alarm below 7 VDC.

VISUAL AND AUDIBLE ALARM SIGNALS

This SAFE-T-ALERT™ CO Alarm is designed to be easy-to-operate. The alarm has two indicator lights that display a specific color for each monitored condition. There also is a matching sound pattern for alarm conditions.

CO ALARM

The Red CO LED will flash and the alarm will sound 4 “BEEPS” then silent for 5 Seconds. **IMMEDIATE ACTION IS REQUIRED.** See **Procedures To Take During An Alarm.** This cycle will continue until the TEST/Mute button on the front of alarm is pressed. Ventilate the RV. The RED light will stay ON until the CO has cleared, or the alarm will reactivate in approximately 6 minutes if the CO is still present. **DO NOT RE-ENTER THE RV.** This alarm will return to normal operation after the RV is properly ventilated.

MALFUNCTION/SERVICE SIGNAL If any malfunction is detected, the Gas LED will remain off and the Operational/CO LED will alternate Red/Green and the alarm will sound once every 15 seconds. Press the Test/Mute button. If the Test/Mute button does not clear the signals, check the battery voltage. **If the battery voltage is not low and the unit will not return to normal operation, immediately remove the alarm and return for service or warranty replacement.** See the warranty section in this manual.

<u>OPERATION</u>	<u>AUDIBLE SIGNAL</u>	<u>VISUAL SIGNAL</u>
WARM UP	NONE	FLASHING GREEN
NORMAL	NONE	STEADY GREEN
CO ALARM	4 “BEEPS” 5 SECONDS OFF	STEADY RED
ALARM MALFUNCTION	BEEP” EVERY 25 SECONDS	ALTERNATING RED/GREEN
END OF LIFE SIGNAL	BEEPS EVERY 25-30 SECONDS	RED RED GREEN GREEN FLASHING

MEMORY FEATURE – This alarm has a Peak Level Memory feature that remembers the approximate amount of CO that activated it. The memory feature does not record brief exposure to CO that would not activate the alarm. This alarm will indicate one of four levels with chirps and blinks with the CO LED:

To activate alarm level memory, press the TEST/RESET button for less than 1 second.

- 1 Chirp and 1 Green Blink = CO memory is clear
- 2 Chirps and 2 Red = below 100 ppm
- 3 Chirps and 3 Red Blinks = below 200 ppm
- 4 Chirps and 4 Red Blinks = above 200 ppm

End of Life Signal – The Sensor has a 5 Year Service Life

All 65 Series models include an End of Life (EOL) Signal indicating the sensor has reached the end of its service life and you must replace the alarm. The signal is the LED flashing RED RED GREEN GREEN with a beep every 25-30 seconds. The EOL Signal may be

reset by pushing TEST / RESET button on the alarm. This will reset the EOL Signal for a period of 72 hours (3 days) for a total of up to 30 days. After 30 days the signal cannot be reset and the alarm must be replaced. **DO NOT DISCONNECT THE ALARM UNTIL YOU HAVE A REPLACEMENT ALARM AVAILABLE TO INSTALL.**

TROUBLE-SHOOTING GUIDE

Use this chart to trouble-shoot problems with this 65 Series Alarm.

<u>PROBLEM</u>	<u>CAUSE/SOLUTION</u>
Green Operational LED Off	<ol style="list-style-type: none"> 1. Wire Connection 2. Reversed Wiring 3. Main Power Off 4. Missing or Blown Fuse 5. Contact Customer Service
No Sound When Testing	Contact Customer Service
No Red LED When Testing	Contact Customer Service
Locked In Alarm	Contact Customer Service
MALFUNCTION ALARM	
LED Flashing Red/Green - Beeps Every 25 Seconds	<ol style="list-style-type: none"> 1. Check Battery Voltage
Battery Voltage is Good and Alarm Will Not Reset	<ol style="list-style-type: none"> 2. Contact Customer Service
End of Life Signal LED Flashing RED RED GREEN GREEN Beeps Every 25 Seconds	<ol style="list-style-type: none"> 1. Press Test/Reset Button to reset for 72 Hours. Can repeat for up to 30 Days 2. Replace Alarm

HOW TO TAKE CARE OF YOUR ALARM

This CO Alarm is designed to be as maintenance free as possible. To keep your alarm in good working order, you must:

- **TEST THE ALARM WEEKLY using the Test/Reset Button.** See the section, **Test Procedure**, in this manual for further information.
- **VACUUM THE DUST OFF THE ALARM COVER.** At least once a year (more frequently in dusty locations), use the soft brush attachment from your vacuum to clean the alarm covers.
- **CLEAN THE ALARM COVER WHEN DIRTY.** Wash the alarm cover by hand. Use a cloth dampened in clean water. Dry with a soft cloth.
- **DO NOT SPRAY CLEANING AGENTS OR WAXES DIRECTLY ONTO THE FRONT PANEL.** This action may damage the sensor, cause an alarm or cause an alarm malfunction.
- **OBSERVE THE COLOR OF THE INDICATOR LIGHT.** At frequent intervals and during your weekly test, check the indicator light on the on the front panel of the alarm.
- See the section, **Operation**, in this manual for further information.

SPECIFICATIONS

MODELS	65-541, 65-541-R, 65-541-MS, 65-541-R-MS 65-542, 65-542-R, 65-542-MS, 65-542-R-MS
POWER SUPPLY	12 VDC
NOMINAL CURRENT DRAW	108mA
OPERATIONAL TEMPERATURE	-40° F to +150° F -40° C to +66° C
RELATIVE HUMIDITY	15% (+/- 5%) to 95% (+/- 4%)
AUDIBLE OUTPUT	85 dB @ 10 feet
CO ALARM TRIGGER	4 -15 Minutes @ 400 ppm
CASE DIMENSIONS	65-541 5.5"W x 3.5"H x 1.38"D 65-542 6.5"W x 3.5"H, 1.38"D
WARRANTY	1 Year Limited
TESTING LABORATORY STANDARD	Underwriters Laboratories UL 2034, Third Edition

PROCEDURES TO TAKE DURING AN ALARM

Follow the alarm procedures for your country. The emergency number depends on your travel location.

PROCEDURES TO TAKE DURING A CO ALARM IN THE USA

 **WARNING:** Actuation of this device indicates the presence of carbon monoxide (CO) gas, which can KILL YOU. If signal sounds (4 beeps and flashing or solid red light): **1)** Operate the Test/Mute button; **2)** Call your emergency local service (Phone Number _____) (fire department or 911); **3)** Immediately move to fresh air - outdoors or by an open door/window. Check that all persons are accounted for. Do not reenter the premises or move away from the open door / window until the emergency responders have arrived, the premises have been aired out and your alarm remains in its normal operation. **4)** After following steps 1-3, if your alarm reactivates within a 24-hour period, repeat steps 1-3 and call a qualified appliance technician. (Phone Number _____) to investigate for sources of CO from fuel burning equipment and appliances, and inspect for proper operation of this equipment. If problems are identified during this inspection have the equipment serviced immediately. Note any combustion equipment not inspected by the technician and consult the manufacturers' instructions, or contact the manufacturer directly, for more information about CO safety and this equipment. Make sure that the motor vehicles are not, and have not been, operating in an attached garage or adjacent to the residence.

PROCEDURES TO TAKE DURING A CO ALARM IN CANADA

 **WARNING:** Actuation of this device indicates the presence of carbon monoxide (CO) gas which can KILL YOU. If signal sounds (4 beeps and flashing or solid red light: 1) Operate the Test/Mute. Immediately move to fresh air - outdoors or by an open door/window. Check that all persons are accounted for. Do not reenter the premises or move away from the open door/window until the emergency responders have arrived, the premises have been aired out, and your alarm remains in its normal condition; 2) call your emergency local service (telephone number _____) (Fire department or 911).

© MTI INDUSTRIES 2011

LIMITED PRODUCTS WARRANTY

MTI INDUSTRIES, INC. warrants to the original retail purchaser that its products will be free from defects of material or workmanship for a period of One (1) year from the date of retail purchase. If proven to have been defective in original materials or workmanship and returned, delivery costs prepaid, MTI INDUSTRIES, INC. will replace this product free of charge.

LIMITS OF WARRANTY

Replacement is your exclusive remedy under this limited warranty or any other warranty (including any implied warranty of merchantability for a particular purpose). Any and all implied warranties or merchantability or fitness for a particular purpose shall be limited to the warranty period from the original date of retail purchase. MTI INDUSTRIES, INC., its dealers and distributors shall in no case be responsible or in any way liable for any incidental or consequential damages for any reason. Some states do not allow the limitation or exclusion of incidental or consequential damages, or allow limitations on how long an implied warranty lasts, so the above limitations may not apply to you. This warranty gives you specific rights, and you may also have other rights, which may vary, from state to state.

PRODUCT NOT WARRANTED

NOTE- There are no user serviceable parts inside the case. Opening any SAFE-T-ALERT™ product for any reason voids the warranty. This warranty does not cover damage or failure resulting from acts of God, abuse, misuse, neglect, or faulty installation.

WARRANTY RETURN PROCEDURES

It is MTI's experience that a CO Alarm is sounding for a reason. Call, ask your dealer to call, or e-mail our Customer Service Department (as listed below) to trouble shoot the situation.

Customer Service Phone No. - 800-383-0269

Fax No. 847-546-9007

E-mail Service@mtiindustries.com

Web Site: www.mtiindustries.com

If Customer Service determines that the unit is defective, a Replacement Authorization (RA) number will be issued. **No product will be accepted for service or replacement without first obtaining a RA number.**

If authorized, return this product to:

MTI Industries, Inc.

Warranty Dept. RA # (INSERT RA NUMBER HERE)

31632 N. Ellis Drive Unit 301

Volo, IL 60073

NOTE: Mark the RA number in the area shown on the outside of the box!

OWNERS REPLACEMENT RECORD

Replace this SAFE-T-ALERT™ 65 SERIES CO alarm within 5 years, of the installation of the alarm.

Installation Date _____

Replace Date _____

Installer _____

NOTE: The replacement date indicates the date beyond which the device may no longer detect accurately.